Proposed Plan Change 73

Annotated provisions of Chapter 3 of the Operative District Plan showing proposed changes

The new provisions (as notified) are shown as underlined, and deleted provisions are shown as ~~struck out~~.

3. DISTRICT PLAN GENERAL PROVISIONS

3.1 Guide to the District Plan

3.1.1 Introduction

Section 3.1 simplifies the task of finding out what you wish to know from the District Plan. It describes the steps to follow in using this document, and tells you how you can obtain further information and what you may need to do to get a resource consent. This section also provides advice on how to find out what may happen in your area in future.

3.1.2 How to Use the Plan

- **Check the maps**

The place to start is with the maps. First find the location of the site that you are interested in.

What type of area is it in? Each type of area has its own special rules. The areas are:

- Rural
- Residential
- ~~Suburban~~ Centres
- Business Areas
- Institutional Precincts
- Airport and Golf Course Recreation Precinct
- Central Area
- Open Space
- Conservation Sites

You must also be aware of other rules that may apply. They usually have a specific function, such as rules applying to character areas aimed at protecting particular, distinctive qualities. Run through the following to check whether it is likely that other rules might apply.

- Is the site you are looking at within a **character or heritage area**?
- Is there a **Design Guide** associated with this area?
- Is the site close to the **boundary** between different areas?
- Is the property near a site identified as being of significance to **tangata whenua**?
- Does the property contain an item listed for **heritage** reasons?

- Is the site within or on the boundary of a **Conservation Site** or close to the **coast**?
- Is the site subject to a **designation**? This is shown by notations on the maps.
- **Check the rules for the area your site is in**

When you have located on the map the area that your site is in, and you have an idea of its surroundings, turn to the part of the Plan that deals with that area.

Each part of the Plan contains an introductory statement that describes the area, and is followed by the objectives, policies and rules that are applicable throughout the area.

- **Check for other rules**

There may also be other rules elsewhere in the Plan that are applicable to your site or to the activity that you wish to undertake. For example, if you are considering using a heritage building within the Central Area you will need to consult the Central Area provisions as well as the rules relating to the use of heritage buildings.

If your site is subject to a **designation**, the lists in Chapter 24 will tell you which authority is responsible for the designation, and whose permission you will need to obtain to undertake work on the site.

In the right hand margin of the page, **column notes** refer you to some of the other provisions that are related to those you are looking at.

- **Check definitions**

Throughout the Plan, words have been used that may have legal or special meanings that are sometimes different from those in common usage. These words are defined in the Definition section (refer to 3.10) or in the Resource Management Act 1991.

- **Applying for any consents you need**

The activity you want to go ahead with will be identified as a Permitted, Controlled, Discretionary (Restricted), Discretionary (Unrestricted) or Non-complying Activity. In the **Central Area** and **Suburban Centres**, all activities are permitted (provided they comply with conditions) unless the Plan specifies that they need a resource consent. In all other areas, the reverse applies: unless activities are specifically permitted, they need a resource consent.

Even if your activity is not specifically listed in an area, it may still be provided for. The Plan is not concerned with activities that are so minor that they have practically no effects: for example, digging a garden is not considered to be earthworks.

Activities that are Permitted can be proceeded with as of right but they must meet the conditions specified in the Plan.

For building works and activities that are identified as Controlled, Discretionary (Restricted), Discretionary (Unrestricted) or Non-complying, you need to get a **resource consent**. The consent application is assessed against Part II and Sections 104 and 105 of the Resource Management Act. The following table shows the difference between the types of activities described within the District Plan.

Type of Activity	Do I need a Resource Consent?	Explanation
Permitted	No	As of right subject to conditions.
Controlled	Yes	Consent will be granted but conditions may be placed on the consent in respect of the matters controlled.
Discretionary (Restricted)	Yes (but discretion is limited to a particular part of the activity)	Consent may be granted. Conditions may be placed on the consent in respect of the restricted matters identified in the Plan.
Discretionary (Unrestricted)	Yes	Consent may be granted. Conditions may be placed on the consent.
Non-Complying	Yes	Consent may be granted. Conditions may be placed on the consent. Council must be satisfied that the granting consent will not be contrary to the objectives and policies of the Plan.

3.1.3 Resource Consents and Plan Changes

3.1.3.1 Resource Consents

The procedures for applying for a resource consent are described in Part VI of the Resource Management Act. Section 3.2 of the Plan specifies what you must do to satisfy Council's requirements before an application will be accepted.

Information is also available from Council to explain the process in more detail and to tell you what you can do to help the application go smoothly.

The amount of detailed information you need to provide depends on the type of resource consent. For example, subdivision consents require a high level of detail; a resource consent to put up a sign may not.

Depending on the location, nature and type of application and the nature of the proposal, you may need to consult or get the consent of affected parties (these might for example include neighbours, residents' groups, tangata whenua, environmental groups).

In some cases, you may also need to get consent from the Wellington Regional Council.

You need to undertake consultation with any parties affected by your proposal as required under Section 88(6) of the Resource Management Act. The level and extent of community consultation depends on the impacts that your proposal will have. In general, the greater the effects, the more extensively you need to consult.

The process of consulting people allows them to understand the nature of the proposal and let their views be known. Done properly, consultation can reduce time and costs later on in the resource consent process.

Special consultation procedures may apply to activities near identified sites or precincts of significance to tangata whenua or Maori. Heritage buildings may also require special consultation procedures.

To have your application processed, you may need to pay a fee. The amount of the fee depends on what your activity is and the type of resource consent you need.

3.1.3.2 Plan Changes

Where you believe the rules in your area are no longer relevant or are inappropriate, you may apply to have the District Plan changed. The process for a Plan Change, and details of the information to be supplied with any such application, are detailed in the First Schedule to the Act.

3.1.4 Future Developments

If you are considering buying a property or undertaking a development it may be wise to consider what can happen in the immediate neighbourhood. For example, although a view from a building may currently exist, the neighbouring house could be pulled down and replaced with a taller one.

The District Plan can help give you an idea of what could happen near a site or property.

You can also obtain other information held by Council about your land or project by applying for a **Land Information Memorandum (LIM)** or **Project Information Memorandum (PIM)**.

LIMS are summaries of all the information that Council holds on a particular piece of land or building. PIMS are summaries of all the information the Council holds on the land relating to a particular project or work, and outlines other consents required to complete that project or work. A fee is charged to provide this information.

3.1.5 Further Advice

If, having read the relevant Chapters of the Plan, you are unsure about any aspect of the rules, or if you feel that you would like further information or explanation, please contact the Council. Make sure you are familiar with the Plan provisions that relate to your site or application. This will make the task of Council staff easier. They will be able to give you more advice about the things you wish to know.

If you need a resource consent it is your obligation to prepare your application and to provide all the information about the effects your project may have on the environment. Council staff cannot do this for you.

Often the advice of an independent planning consultant, surveyor, architect or solicitor will be helpful to you, whether you are an applicant, or want to make a submission on someone else's application.

3.2 Information to be Submitted with an Application for a Resource Consent

3.2.1 Requirements for Information

For Council to be able to process an application for a resource consent, an applicant must provide adequate information to enable the effects of the activity to be assessed (in accordance with section 88(4) of the Act or in the case of a subdivision consent, sections 88(4) and 219).

Applications should be in the same or similar format as Form 5 of the Resource Management (forms) Regulations 1991. Copies of this form can be obtained from the Council offices.

Where Council considers that insufficient information has been supplied, further information will be requested under section 92 of the Act and the resource consent or plan change will not be advanced until the requested information is supplied.

Applications should be discussed with Council staff before they are formally lodged to ensure that the following requirements are met. This enables any minor difficulties to be resolved in an informal way and will avoid delay caused by formal requests for more information.

3.2.2 Land Use Consents

An application for a Land Use Consent shall include:

3.2.2.1 A description of the activity for which consent is sought, and its location.

3.2.2.2 An assessment of any actual or potential effects that the activity may have on the environment, and the ways in which any adverse effects may be mitigated.

Note: Section 88(6) of the Act requires assessments to be in such detail as corresponds with the scale and significance of the actual and potential effects that the activity may have on the environment, and shall be prepared in accordance with the Fourth Schedule to the Act.

3.2.2.3 For activities within a Maori Precinct, a description of the type and extent of consultation with tangata whenua and other Maori and any outcomes of the consultation.

3.2.2.4 Any information required to be included in the application by the District Plan or the Act's regulations. This could include noise assessment, a traffic impact report or an Urban Design Statement.

3.2.2.5 A statement specifying all other resource consents that the applicant may require from any consent authority in respect of the activity to which the application relates, and whether or not the applicant has applied for such consents.

3.2.2.6 **Site information.** The following information must be supplied:

- the correct street address
- the legal description(s) of the site

- current copies of all certificates of title.

3.2.2.7 **Site plans.** Site plans must be drawn at a 1:100 or 1:200 metric scale where possible, or to such a scale to show sufficient detail of the proposal to enable Council to determine its effects. If the plans are larger than A3 size copies reduced to A3 must also be provided. The site plans must show:

- a north point accurately orientated
- a unique plan number and title describing the proposal and the site.

3.2.2.7.1 The applicant must provide a site plan detailing where relevant the **existing situation** including:

- details of hazardous areas (for example uncompacted filling or flood prone areas)
- topography (noting significant landforms natural features [and identified ridgelines and hilltops]^{PC33})
- waterbodies and catchment orientation
- vegetation (including that located on adjacent road reserve or surrounding properties) and/or habitats of indigenous fauna
- all certificate of title boundaries
- road frontages
- existing buildings (indicating those to be retained)
- buildings on adjacent sites.

3.2.2.7.2 The applicant must provide a site plan detailing where relevant the **proposed development** including:

- design of earthworks and final levels and contours of the site
- layout and location of proposed structures and buildings or alterations to existing structures and buildings
- location of proposed activities, vehicle parking, servicing, circulation and manoeuvring, pedestrian and vehicular access
- floor plans
- calculation of site coverage
- [a landscaping plan that outlines]^{PC56} all landscape design, site planting and fencing.

3.2.2.8 The applicant must provide, where relevant, elevation drawings, numbered and drawn to a metric scale of generally 1:100 or such as to clearly show the:

- relationship of buildings to existing and finished ground levels
- extent of compliance with relevant plan rules including solar access and maximum building height
- elevations from the street showing the relationship of proposed structures to structures on adjacent sites, including the location of existing private outdoor spaces and main living area windows (where these have outlook over the development).

3.2.2.9 Where an application for a Land Use Consent includes an activity involving the storage, use, handling or disposal of hazardous substances which does not comply with the conditions for Permitted Activities then the applicant must provide a Site Management Plan which addresses:

- the hazardous properties and risks to the environment and public safety associated with the substances, products and processes present on-site
- on-site systems for the handling, storage and disposal of hazardous substances
- measures to avoid contamination of the environment
- measures to mitigate any adverse effects arising
- consideration of the size and nature of the possible emergency events
- detailed procedures and actions to be taken in the event of an emergency
- liaison with the emergency services, regulatory authorities and neighbours
- safety procedures.

The Site Management Plan should relate to that portion of the site where the hazardous substances are used, stored, or handled, and that area which may be directly affected by an accidental release of the hazardous substances on site.

Where a hazardous facility has an Environmental Management System (to ISO 14001 or equivalent) or a recognised integrated Health, Safety and Environment Management System, then a Site Management Plan will not be required provided that the system addresses on-site hazardous substance management and can demonstrate compliance with the requirements of the standard.

3.2.2.10 Where an application for a land use consent includes an activity subject to Rule 5.3.11 the following information will be required:

- council building consent/archival data detailing the date of construction or approval for construction; or
- where Council records are inadequate to determine the date of construction, or approval for construction, a report from a suitably qualified conservation architect detailing their professional opinion as to the date of construction may be required. This is only required where requested by the Council or its authorised delegate under Section 92 of the Resource Management Act 1991; and
- information on the outcome of consultation with the local residents' association about the possible demolition of the building. The relevant associations are the Thorndon Society in Thorndon and the Mt Victoria Residents' Association in Mt Victoria, or if these organisations are no longer in existence, the organisation or organisations which the Council determines have a record of representing the public interest in relation to Thorndon and Mt Victoria.

3.2.2.11 Any other information necessary to determine the effects of the proposal.

3.2.2.12 **Note in respect of Controlled Activities and Discretionary Activities (Restricted).**

For Controlled Activities and Discretionary Activities (Restricted), applications will only be assessed with regard to those matters specifically identified in the District Plan rules. The information to be supplied must include an assessment of any likely effects on the environment. This can be limited to that which is necessary to address the matters under consideration.

[3.2.2.13 Except for utilities less than 6m² in area and a maximum height of 2m, where an application for a Land Use Consent is for a development within the Hazard (Fault Line) Area, the applicant must provide a geotechnical report and an engineering design report.

A geotechnical report will include, to Council's satisfaction, the results of relevant geotechnical investigations. The Council will determine the relevance of undertaking geotechnical assessments on a site by site basis in recognition that hazard related risks and the ability to investigate the hazard, vary within individual properties.

The engineering design report must detail additional engineering measures that will be adopted to mitigate potential adverse effects from a fault rupture hazard event.]^{PC22}

[NB: 3.2.2.14 and 3.2.2.14A inserted by District Plan Change 48 (Central Area)]

3.2.2.14B For the purposes of Chapters 6 and 7 of the District Plan, a **wind assessment report**, which is based on the expert opinion of a qualified wind specialist, must be provided for the construction, alteration, or addition to buildings and structures that do not comply with the maximum permitted building heights in standard 7.6.2 (unless 3.2.2.14AC below applies).

The form and content of a wind assessment report is outlined in Appendix 2 of Chapter 7

~~The report must conclude that the development is highly likely to maintain and improve pedestrian wind conditions before it will be accepted under Rule 7.3.7.~~

The report must conclude that the overall effect of the building development will not reduce the existing pedestrian wind conditions before it will be accepted under Rule 7.3.7.

3.2.2.14C At the discretion of Council officers, a wind tunnel test report may also be required for the construction, alteration, or addition to buildings and structures that do not comply with the maximum permitted building heights in standard 7.6.2.

The wind tunnel test study must examine the effects of the proposed building upon all areas open to the public, including roads, parks, malls, plazas, public carparks, the immediate forecourt area and entranceways to the proposed building/s. The proposed development must be tested against the existing situation except where the site is currently cleared. If the site is cleared, the proposal must be tested against any building which existed within the previous 5 years.

Details of the test requirements, and the form and content of a wind tunnel test report is outlined in Appendix 2 of Chapter 7.

Examples of situations where a wind assessment report may be provided instead of a wind tunnel test report include:

- Where the proposed building or addition is consistent with other building heights in the neighbourhood, is only a small change in scale compared to the existing building and incorporates wind mitigation measures such as verandahs, setbacks and breezeways;
- Where the proposed work is for a minor rooftop addition (eg. lift or ventilation room) which is setback from all sides of the building;
- Where the proposal involves a structure that will not impede wind flows, eg. aerials, masts.

3.2.3 Subdivision Consents

An application for a Subdivision Consent shall include:

- 3.2.3.1 A design statement as per 3.2.4.1.
- 3.2.3.2 An assessment of any actual or potential effects that the activity may have on the environment, and the ways in which any adverse effects may be mitigated.

Note: Section 88(6) of the Act requires assessments to be in such detail as corresponds with the scale and significance of the actual and potential effects that the activity may have on the environment, and shall be prepared in accordance with the Fourth Schedule to the Act.

Section 88(5) provides that the assessment of effects on the environment required by subsection (4)(b) of the Act in respect of an application for a resource consent relating to a Controlled Activity, or a Discretionary Activity over which the local authority has restricted the exercise of its discretion, shall only address those matters specified in a plan or proposed plan over which the local authority has retained control, or to which the local authority has restricted the right to exercise its discretion, as the case may be.

- 3.2.3.3 Any information required to be included in the application by the District Plan or the Act's regulations.
- 3.2.3.4 A statement specifying all other resource consents that the applicant may require from any consent authority in respect of the activity to which the application relates, and whether or not the applicant has applied for such consents.
- 3.2.3.5 **Site information.** The following information must be supplied:
- a legal description of the site
 - current copies of all certificates of title
 - where relevant, an assessment, including diagrams, of the significant views onto and off the development site.
- 3.2.3.6 **Site plans.** Site plans must be supplied. They must be drawn to an appropriate stated metric scale to show sufficient detail of the proposal to enable Council to determine its effects [(eg. 1:200, 1:500)]^{PC56}. If the plans are larger than A3 size copies reduced to A3 must also be provided. The site plans must show:
- a north point accurately orientated
 - a unique plan number and title describing the proposal and the site
 - Wellington City Council record sheet numbers
- 3.2.3.7 The applicant must provide a site information plan detailing the existing situation including:
- topographical information, wherever possible in terms of Wellington City Datum, together with a certificate as to its origin and accuracy
 - details of hazardous areas (for example, uncompacted filling or flood-prone areas)
 - existing buildings and buildings on adjacent sites
 - landforms and landscape elements [including identified ridgelines and hilltops]^{PC33}

Site information such as contours, existing vegetation and the position of dwellings on neighbouring lots is essential to allow impact on amenity of proposed development to be determined, especially in respect of subdivision within established residential areas.

- waterbodies and catchment orientation
- the location and areas of any existing esplanade reserves, esplanade strips, or access strips
- all significant areas of vegetation (including any vegetation located on adjoining road reserve or properties) and/or significant habitats of indigenous fauna
- existing street names and numbers
- existing easements and covenant areas
- the location of existing public transport stops, and pedestrian access routes to those stops.

3.2.3.8 The applicant must provide a **[site development plan]** ^{PC56} detailing the proposed subdivision development including:

- the position of all proposed allotment, and certificate of title, boundaries
- the areas of all new allotments (except in the case of a subdivision to be effected by the grant of a cross lease, company lease or by the deposit of a unit plan)
- [indicative building sites and building footprints]*
- indicative vehicle accessways and indicative parking and manoeuvring areas if applicable*
- proposed site contours
- indicative open space areas*] ^{PC56}
- location and type of all proposed trees and other vegetation, including all existing vegetation to be retained
- [major new landscaping elements (eg. Fences, trees and hedges)
- any proposed earthworks, including retaining walls (indicating height, and intended form or type of construction)
- areas of on-site drainage] ^{PC56}
- the street reserve proposed to be set aside as new road, including all areas of public open space intended for recreational purposes, together with drawings sufficient to describe the plan and three dimensional qualities of typical and unique or special areas of the development
- formation widths and grades of proposed roads and rights-of-way, parking bays, bus stops, speed control devices and pedestrian walkways
- proposed easements and covenant areas
- the location of proposed public transport stops and pedestrian walkways, and walking distances to public transport stops
- the location and areas of new reserves to be created, including any esplanade reserves to be set aside on a survey plan under section 231
- the location and areas of esplanade strips proposed to be created under section 232 to meet the requirements of the District Plan
- the location and areas of any land below mean high water springs of the sea, or of any part of the bed of a river or lake, which is required under section 237A are to be shown on a survey plan as land to be vested in the Crown
- information to show compliance with any other District Plan rule.

Site information such as contours, existing vegetation and the position of dwellings on neighbouring lots is essential to allow impact on amenity of proposed development to be determined, especially in respect of subdivision within established residential areas.

Within the subdivision provide a realistic means of addressing the District Plan standards for building.

* [Note: this information may not be required for proposed allotments over 400 metres squared, depending on the topographical constraints of the site (eg. Slopes greater than 15 degrees).] ^{PC56}

3.2.3.9 [(1:200 – 1:500 colour aerial photograph):] ^{PC56}

The applicant must provide an annotated print from the most recent 1:500 aerial photograph.

- [overlaid with existing contours and property boundaries.
- extending at least 20 metres beyond all side and rear boundaries, and showing frontages of properties across the street.] ^{PC56}

3.2.4 Design Guide Applications

Any application for a resource consent that is to be assessed against a Design Guide must be accompanied by a Design Statement.

The submission of a clear and sufficiently comprehensive application including all the material listed below (general and specific requirements) will assist the approval process by demonstrating that all relevant matters have been addressed.

The primary concern of any urban design assessment is not the architectural design qualities of a proposal as such, but the way that the proposal is integrated into its surroundings through the quality of its design.

The urban design assessment of a proposal will evaluate the architectural design only in terms of its contribution to the overall quality of the urban environment.

A development will be judged in relation to the contribution that it makes to the enhancement of the public environment (including, among other elements, streetscapes, urban form, public spaces, views, visual qualities of the built environment and connections to other buildings) and this should be made explicit within the design statement. The design statement should also illustrate the potential effects that the proposed development may have on the fabric of the city and the expected changes it may generate.

3.2.4.1 General requirements

Design Statement

The design statement will set out the design principles of the development proposal. This statement will comprise a significant element of the assessment procedure. It must:

- demonstrate how, through the design process, the respective design guide objectives and guidelines have been considered, for example, through considering options, before a final solution has been reached
- describe the significant features of the development site
- outline the relevant history of the site
- explain how the proposal strengthens or enhances the existing form and character of the city
- where the development is of a size or in a location with city-wide significance, include a description of how the development is seen in the context of the wider city and how it links into that context
- describe how the development integrates into its surroundings and the contribution that it makes to the overall quality of the environment.

If a proposal does not comply with the objectives of the Design Guide, the Design Statement must convincingly justify that the development does not detract from the intention of the Design Guide and that the proposal does not create an adverse effect on the environment.

If a proposal does not comply with guidelines or specific requirements under 3.2.4.2, the Design Statement must convincingly justify the applicant's choice of the particular approach and demonstrate how the objectives of the Design Guide are satisfied.

3.2.4.2 Specific requirements

3.2.4.2.1 For multi-unit housing:

In addition to the requirements of 3.2.4.1, each application must also provide where relevant the following:

1. A development summary:

This must provide the following information:

- total site area and proposed number of dwellings
- a calculation of site coverage
- the area of the site associated with each individual dwelling
- the area and overall dimensions of the major private outdoor space associated with each individual dwelling
- number of off-street car-parking spaces
- the area of any shared open spaces within the development
- notes to indicate the intended general type of external cladding materials for all buildings and site-works including walls and fences at the street edge.

2. Additions to site plan:

- the position and use of buildings on immediately adjacent sites including the location of existing private outdoor spaces, and main living area windows where these have outlook over the development
- the street immediately adjacent, including any street trees
- proposed public access-ways, driveways, car-parks and footpaths, including designated public open space or communal space.

3. Indicative typical dwelling floor plans at a scale of not less than 1:200 showing:

- [the indicative internal layout of typical and any non-typical dwellings, with common furniture items drawn to scale and door opening arcs illustrated.]^{PC56}
- the location of the private open space, car-parking and external storage space for each dwelling.

4. Additions to elevation drawings:

- height of fencing at site boundaries.
- [in Mt Cook, Newtown and Berhampore (as shown in Appendix 9, Chapter 5) a cross section of the front elevation (at a scale of not less than 1:50) showing the depth of façade relief.]^{PC39}

5. Assessment of design to avoid, remedy or mitigate the adverse effects of infill development in established areas:

Development in established areas may have an impact on both the streetscape and on adjacent development. To assist assessment of this impact, the following additional information may be required:

a statement or description of planning and design measures that have been incorporated to avoid, remedy or mitigate the adverse effects on neighbours of:

- loss of visual privacy through overlooking of outdoor space and views into living areas of adjacent dwellings
- loss of daylight and aspect due to the overshadowing of existing private outdoor space and windows to main living areas
- the visual bulk of large walls
- noise from the new activity.

6. Streetscape appraisal:

In addition, where a development has a presence on a street which is generally recognised as having a character that is of significance to, and is valued by, the community, then a streetscape appraisal will be required. This will include:

- street elevations to a scale of 1:100 which show the development and the [four]^{PC39} properties on either side
- photographs taken from across the street showing the buildings described in the street elevation.

3.2.4.2.2 For the Thorndon Character Area:

In addition to the requirements of 3.2.2, each application must also provide the following (except for modifications to existing buildings where no part of that modification is visible from across the street):

- street elevations to a scale of 1:100 which shows the development and the two properties on either side
- photographs taken from across the street showing the buildings described in the street elevations
- a plan at a minimum scale of 1:100 showing these properties and the front of the properties that face the site across the street.

3.2.4.2.3 For the Central Area Design Guide:

Additions to the Design Statement are required for developments within the Central Area that:

- are adjacent to or that front public spaces

In this case the Design Statement should clarify how the proposal will contribute to the quality of those public spaces.

or

- are anticipated to have significant visual effects on the City's skyline and urban form.

In this case the Design Statement should clarify how the proposal will contribute to the cityscape when viewed from close up or from a distance.

[3.2.4.2.4 For the Lambton Harbour Area

For building and open space developments within the Lambton Harbour Area each application must provide a design statement that sets out how the design principles of the proposal respond to the values, principles and objectives of the *Wellington Waterfront Framework (April 2001)*. In particular the design statement should identify how the proposal will:

- be in character with the waterfront as a whole and maximise the unique value of the waterfront location
- express the heritage and history of the waterfront
- enhance the relationship between open spaces and adjacent buildings, structures and water areas
- support and contribute to the quality of surrounding open spaces
- contribute to the provision of different open spaces and buildings that cater for diverse uses and activities compatible with a waterfront location and
- enhance physical access and visual links between the city and the waterfront.

The Design Statement should identify how the proposal will contribute toward an overall sense of collective ownership and involvement.]^{VAR22}

[Note: Sections 3.3 to 3.6 do not form part of DPC73. To save space they have been excluded]

3.7 The Status of Formed and Unformed Roads[, Service Lanes and Motorways]^{PC34}

On the District Plan Maps, all formed legal roads are uncoloured, and all unformed legal roads are coloured blue/grey.

With regard to the application of District Plan objectives, policies and rules, the Plan provisions of the area in which any formed or unformed legal road,[service lane or motorway]^{PC34} is located shall apply.

[Specific provisions apply under the following circumstances:]^{PC34}

- Where a road [or service lane]^{PC34} is stopped, the Plan provisions for the area on which the stopped road is located shall apply.
- Where a formed, unformed or stopped road, [service lane or motorway]^{PC34} is bounded by different areas, the demarcation between areas is the centre of the road.
- [With regard to the coastal unformed legal road from Te Rimurapa Headlands to Makara Beach which is abutted by the Rural Area, the Conservation Site provisions of the Plan shall apply.]^{PC34}
- For the subdivision of roads to facilitate road stopping, refer to the provisions for subdivision in each area.”

[In respect of the above, road, motorway, and service lane are defined in Section 315 of the Local Government Act 1974 and Section 43 of the Transit Act 1989]^{PC34}.

3.8 Coastal Issues

3.8.1 Mean High Water Springs

3.8.1.1 The Natural and Urban Coast

The line of Mean High Water Springs (MHWS), as defined in the Act, provides the demarcation line between the responsibilities of the Wellington City Council and the Wellington Regional Council for the use, protection and development of the coastal environment. The District Plan controls the landward side of this line and complements the Regional Coastal Plan in the management of activities that span MHWS.

Often the coastline is highly modified within the urban area, particularly within the harbour limits, by sea walls and roads. New developments on the sea bed are controlled by the Regional Coastal Plan.

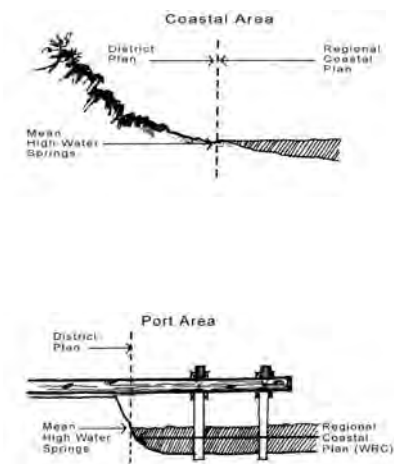

3.8.1.2 The Operational Port and Lambton Harbour

The areas that encompass the operational Port and Lambton Harbour are recognised as being development areas with the potential to impact on both the harbour and central city environments. Any reclaimed land within these areas falls under the jurisdiction of the Wellington City Council under its District Plan. However, areas on wharves seaward of the line of mean high water springs fall within the coastal marine area, and their use and development is controlled by Wellington Regional Council's Regional Coastal Plan. As the major wharves are essentially extensions of the land area, the two councils are working closely together to ensure consistency in administration of the coastal environment.

This may involve the transfer of functions or powers from Wellington Regional Council to Wellington City Council for administration of "land use" activities on major wharf structures. Control of other activities involving the disturbance of the seabed and discharge of contaminants will remain with the Wellington Regional Council.

3.8.2 Reclamation And Declamation

Where land is, or has been, created by reclamation under a rule in a Regional Plan, any activity associated with the future use of the reclaimed land is assessed against the rules for the adjoining area and the effects on the surrounding area. Where the reclamation adjoins two or more areas, Council will determine which area's rules apply, taking into account activities in the surrounding area.

Where land is proposed to be removed by declamation (the opposite of reclamation), the effects of the loss of land are controlled jointly by the Wellington Regional Council through its Regional Coastal Plan and Wellington City Council through its District Plan.

3.9 Construction Standards for Strategic Public Utilities

The Council maintains a Code of Practice for Land Development covering road, sanitary, stormwater and water supply design and construction. The code provides strategic standards, engineering specifications and general guidance to ensure that infrastructure to be constructed by applicants but proposed to become the responsibility of the Council, is constructed to the satisfaction of the Council. In these circumstances, applicants will therefore need to comply with the Council's requirements as set out in the Code, despite the Code not being incorporated into the Plan. Otherwise the infrastructure will not be accepted by the Council, nor would connection be authorised into existing Council infrastructure.

The Code is substantially based on accepted design and construction practice. However, the Council wishes to encourage innovative design and construction practice provided this achieves the outcomes sought, and will accordingly administer the Code with flexibility and sensitivity depending on site specific circumstances.

The City Bylaws specify construction standards for road, sanitary, stormwater and water supply design and construction where this infrastructure will be retained privately.

3.10 Definitions

The following definitions are in addition to those contained within the Act.

ACCESSORY BUILDING: means, in relation to any site, a building or structure, [including a fence or wall,]^{PC6} the use of which is incidental to any lawful activity under the Act or use on that site. [An accessory building may be either a separate building or structure or joined to another building or structure.]^{PC6}

ACCESS LOT: means any separate lot used primarily for access to a lot or to lots having no legal frontage.

[However, if that area of land is:

- 5m or more wide, and
- not legally encumbered to prevent the construction of buildings,

it is excluded from the definition of access lot.]^{PC6}

ACCESS STRIP: means [an access leg or]^{PC6} an area of land [defined by a legal instrument, providing or intended to provide access to a site or sites, or [within the above meaning, an area of land is an access strip if:

- it is less than 5m wide, or
- it is 5m or more in width and is encumbered by a legal instrument, such as a right-of-way, that prevents the construction of buildings.]^{PC56}

ACT, THE: means the Resource Management Act 1991 and includes any amendments.

ADDITION AND ALTERATION (for the purposes of Chapters 20 and 21 [and Rule 17.2.5])^{PC37} includes:

- (i) any work which involves the addition, alteration or removal and replacement of walls, windows, ceilings, floors or roofs, either internally or externally;

but does not include:

- (ii) work which is repair or maintenance; and
- (iii) the partial or total demolition of the object or of any part of it which is identified as being of heritage significance; or any activity within the scope of rules 5.3.11 or 5.4.2.

AERIAL: means the part of a radiocommunication facility or telecommunication facility used or intended for transmission or reception including the aerial mountings but not any supporting mast or similar structure. No part of any aerial excluding the mountings shall be greater than 70mm diameter. This definition excludes any antenna and utility network apparatus.

AIRCRAFT OPERATIONS: means the engine runup, taxi-ing, take-off or landing at an airport of an aircraft, and "operate" has a corresponding meaning.

ANCILLARY RETAIL: means a retail activity that is ancillary to the principal activity within the building or site, and comprises less than 10% of the total gross floor area of the building or site, whichever is the lesser.

ANTENNA: means any device including any dish or panel, excluding aerials, that receives or transmits radio communication or telecommunication signals. This includes the antenna's mountings (including any head arrangement) and radio frequency unit or similar device, but not any mast. The diameter or area of an antenna means:

- In relation to any panel antenna or any other type of antenna that has a length and a width, the area measured by calculating the largest surface area
- In relation to any other antenna, the diameter measured by taking the cross-section of the widest part of the antenna.

Provided that the mountings of any antenna and any radio frequency unit or similar device is not included in the measurement of area or diameter of each antenna, provided that the radiofrequency unit or similar device is smaller in area or diameter than the antenna itself. (Note: any antenna only need meet the area or diameter measurement, as appropriate to the type of antenna, and the measurement is of each individual antenna and is not a cumulative measurement.)

The requirement that antennas and aerials attached to a mast are to be located within a *x*m horizontal diameter circle means:

- if there is a requirement that the horizontal diameter circle is measured through the centre of the mast, or centred on the mast, it means that all antennas, aerials and mountings must be located within the horizontal diameter circle stipulated
- where there is no requirement that the horizontal diameter circle is measured through the centre of the mast, all antennas, aerials and mountings attached to the mast must be located within a *x*m diameter horizontal circle. For the avoidance of doubt all antennas, aerials and mountings must be located within a single circle but there is no requirement for the mast to be located within that circle.

For Illustration Purposes Only:

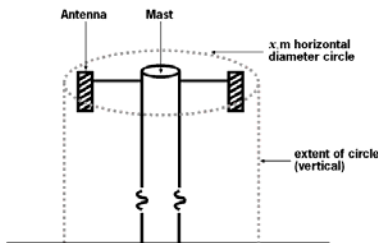

Horizontal Diameter Circle (Side Elevation)
Centred on Mast.

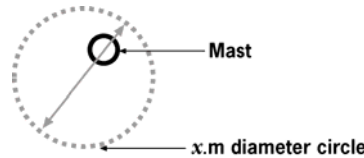

Horizontal Diameter Circle (Plan View) –
not centred on mast
(Mast Located within circle)

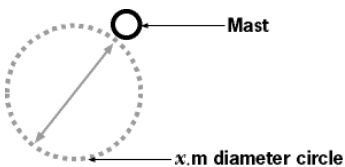

Horizontal Diameter Circle (Plan View) –
not centred on mast

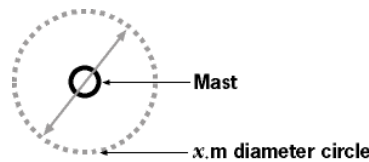

Horizontal Diameter Circle (Plan View)

[ATTACHED LINE: see definition of line]^{PC14}.

AUTOMOTIVE AND MARINE SUPPLIER: means a business primarily engaged in selling automotive vehicles, marine craft, and associated parts and accessories for such vehicles and craft.

BOARDING HOUSE: means a residential building:

- in which board and lodging or lodging alone is provided or intended to be provided for five or more boarders or lodgers (other than members of the family of the occupier or person in charge or control of the building); and
- which provides a permanent address or is a principal place of residence of the boarders or lodgers; and

does not include hotels, motels, a building forming part of a camping ground, motor camp or other premises where residential accommodation for five or more travellers is offered at a daily tariff or other specified time.

BUILDING: means an enclosed structure built with a roof and walls.

BUILDING IMPROVEMENT CENTRE: means any premises used for the storage, display and sale of goods and materials used in the construction, repair, alteration and renovation of buildings and includes builders supply and plumbing supply centres and home and building display centres.

BUILDING SUPPLIER: means a business and associated premises used for the display and sale of goods and materials used in the construction, repair, alteration and renovation of buildings, including plumbing, electrical and building supplies.

CAR RACE STREET EVENT: means a motor vehicle race including practice sessions, run as a temporary activity.

CLEANFILL: means an area used for the disposal of exclusively inert, non-decomposing material into or onto land.

[[**COMMERCIAL SEX ACTIVITIES:** means activities occurring within premises used or intended to be used primarily for exposing, selling, promoting or hiring goods or services related to sexual behaviour; and

- (a) to avoid any doubt includes activities associated with strip clubs, rap parlours, peep shows, lap dancing bars, escort agencies, adult bookshops, adult video shops, adult cinemas, sex shops; but
- (b) does not include activities associated with hospitals, healthcare services, chemists, community welfare facilities, or premises where therapeutic massage is offered and which are not]^{PC2} brothels in terms of the Prostitution Reform Act 2003.]^{PC63}

CONCEPTUAL BOUNDARY: means a line 20 metres from the wall of any building or from any land directly occupied by the activity. If the site boundary is closer to the building or activity, the conceptual boundary definition does not apply.

CONSERVATION ACTIVITY: means any activity which maintains or enhances ecological values and includes recreation activities but does not include any activity otherwise specified in Chapter 19 of this Plan as a Permitted, Controlled or Discretionary Activity.

CONTAMINATED SITE: means a site at which hazardous substances occur at concentrations above background levels and where assessment indicates it poses or is likely to pose an immediate or long-term hazard to human health or to the environment.

CONTEXT ELEMENTS: means, in relation to a Viewshaft, the components that surround focal elements and provide the setting for those elements. They provide the overall context for the view.

CONTINUUM ELEMENTS: means those components that traverse views (usually horizontally) and break up the view into discrete segments such as but not limited to horizons, water lines, edges to housing area, and ridgelines.

COUNCIL: means the Wellington City Council or any committee, subcommittee or person to whom the Council's powers, duties and discretions under the Act have been delegated.

CRITICAL FACILITY: means those network elements that are essential to the functioning of key disaster response systems. This includes, but is not limited to, buildings that (a) house emergency services (ambulance centres, police stations, fire stations), (b) are crucial to the provision of lifeline utilities (power substations, water and sewerage pumping stations) or (c) offer a service that is likely to become a high priority during an emergency (medical centres).

DEMOLITION (FOR THE PURPOSE OF BUILDINGS IN THORNDON, MT VICTORIA [NEWTOWN, BERHAMPORE, MT COOK] ^{PC38} [AND ARO VALLEY] ^{PC50} - REFER APPENDIX 9 TO CHAPTER 5 OF THE PLAN): means the removal, destruction or taking down of the “primary form” of any building, except, where that is permitted as “repair and maintenance”, or where it is within the definition of “additions and alterations”. [In Newtown, Berhampore, Mt Cook and] ^{PC38} [Aro Valley demolition also includes the removal, destruction or taking down of architectural features or elements on the ‘primary elevation(s)’ of any building, except where that is permitted as ‘repair or maintenance’.] ^{PC50}

DEMOLITION AND PARTIAL DEMOLITION FOR THE PURPOSES OF CHAPTERS 20 AND 21 (HERITAGE) AND RULES 5.4.2 (THORNDON CHARACTER AREA) [AND RULE 17.2.5 (CHEST HOSPITAL HERITAGE AREA)] ^{PC37}: means the removal, destruction or taking down of any structure, item or object either in total or in part, except, in the case of a building, where that is permitted as “repair and maintenance”, or where it is within the definition of “additions and alteration”.

DISCRETIONARY ACTIVITY (RESTRICTED): means a Discretionary Activity in respect of which Council has restricted the exercise of its discretion to those matters specified in the District Plan.

DISCRETIONARY ACTIVITY (UNRESTRICTED): means a Discretionary Activity in respect of which Council has not restricted the exercise of its discretion.

DISPLAY WINDOWS: means windows which permit the public to view display space within a building.

[DRAINAGE RESERVE: an area of land, set aside as a separate lot, for public water supply or public drainage purposes.] ^{PC6}

DRIPLINE (OF A TREE): means the greater of:

- (i) the line formed when a vertical line from the outermost extent of the spread of a tree's branches or canopy meets the ground; or
- (ii) the line formed at a radius of half the height of the tree measured from the base of the trunk.

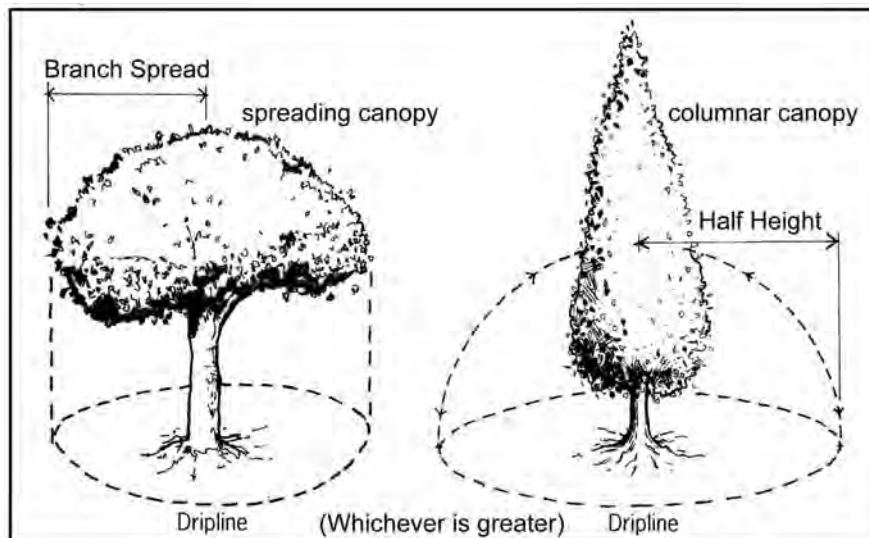

EARLY CHILDHOOD CENTRE: means premises used for the care or education or welfare of four or more children under the age of seven, including but not limited to Kindergartens, Playcentres, Kohanga Reo, Licensed Childcare Centres, Day Nurseries and Creches.

EARTHWORKS: means the removal, relocation or deposit of earth (which includes any substance constituting the land such as soil, clay, sand and rock) from a natural or constructed land formation. Topsoil stripping, turf farming, ground cultivation, and quarrying are excluded from the definition of earthworks.

EDUCATIONAL SERVICES: means but is not limited to academic, vocational, technology and design based education training and research and for the purposes of stating the primary functions of the Mount Cook Precinct in 8.1.1 of Institutional Precincts means but is not limited to tertiary (higher) education; all forms of research (pure and applied); community service, technology transfer, and extension; and business and social services related to the education and research activities of the institution and encompassing all such activities consistent with the function of a modern university.

[ENERGY CONSERVATION: a reduction in energy use.

ENERGY EFFICIENCY: a change to energy use that results in an increase in net benefits per unit of energy.]^{PC32}

[ENVIRONMENTALLY DAMAGING SUBSTANCES: Substances that are not intrinsically hazardous but may cause adverse effects if discharged into the environment in large quantities e.g. oxygen depletion in waterways from substances with high organic contents such as milk, wine, soft drinks etc.]^{PC35}

ESPLANADE LAND: means land alongside a waterbody that may be taken as part of a subdivision to be held as esplanade reserves or esplanade strips.

[EXTERNAL SOUND INSULATION LEVEL ($D_{nT,w} + C_{tr}$): means the standardised level difference (outdoor to indoor) and is a measure of the airborne sound insulation provided by the external building envelope (including windows, walls, ceilings and floors where appropriate) described using $D_{nT,w} + C_{tr}$ as defined in the following Standards:

ISO717-1:1996* *Acoustics – Rating of Sound Insulation in Buildings & Building Elements* using spectrum No.2 (A-weighted traffic noise spectrum).

ISO 140-5:1998 *Acoustics - Measurement Of Sound Insulation In Buildings And Of Building Elements, Part 5: Field Measurements Of Airborne Sound Insulation Of Facade Elements And Facades.*

* This Standard is also known as AS/NZS1276.1:1999 *Acoustics-Rating of sound insulation in buildings and of building elements Part 1: Airborne sound insulation*

The term “external sound insulation level” is used in this Plan primarily as a calculated value to demonstrate compliance with the stated minimum standard of acoustic isolation against sounds arising from outside the building. If field testing of built structures is employed to verify predictions, these tests shall be carried out using ISO 140-5:1998 *Acoustics - Measurement Of Sound Insulation In Buildings And Of Building Elements, Part 5: Field Measurements Of Airborne Sound Insulation Of Facade Elements And Facades.*^{PC23}

FACTORY FARMING: means any process of production of primary produce where the predominant processes are carried out within buildings, including but not limited to, poultry farms, piggeries and mushroom production, but not including glasshouse horticulture.

FARMING AND AGRICULTURAL SUPPLIER: means a business primarily engaged in selling goods for consumption or use in the business operations of primary producers or in animal husbandry.

FLOOD HAZARD AREA: means the area of land which would be inundated during a 1 in 100 year flood event.

(NB: there are other flooding hazards which have not been mapped).

FOCAL ELEMENT: means, in relation to a viewshaft, one of a number of components that are the primary purpose for the view. Focal elements are the outstanding element that a view focuses on.

GARDEN AND LANDSCAPING SUPPLIES: means a business primarily engaged in selling goods for permanent exterior installation or planting and includes: landscaping suppliers; and suppliers of bark, compost, firewood, and paving and domestic paving aggregates.

GOAT FARMING: means the keeping of 10 or more goats on a single site.

GREENFIELD SUBDIVISION: means new subdivisions, usually on the periphery of the urban area, that create new residential or urban areas from land that was previously rural or open space land. Areas are deemed to be residential or urban where the average lot size excluding any balance area is less than the minimum area specified in Rule 15.4.5.

GROSS FLOOR AREA: means the sum of the gross area of the floor or floors of a building or buildings (including any void area in those floors, such as a lift or service shaft) measured from the exterior faces of exterior walls, or from the centre line of walls separating two buildings.

GROSS FLOOR AREA (FOR THE PURPOSE OF ANY RETAIL ACTIVITY): means the total sum of any floor areas of a retail activity or integrated retail development. It does not include floor area occupied by car parking areas, loading and servicing facilities, and toilet and building maintenance facilities.

GROSS FLOOR AREA (FOR THE PURPOSE OF ANY RETAIL ACTIVITY): means the total cumulative gross floor area of a retail activity or integrated retail development. It does not include floor area occupied by car parking areas, loading and servicing facilities, and toilet and building maintenance facilities.

[GROUND LEVEL: means the existing ground level, except:

- where measuring ground level under a building for the purposes of calculating maximum height, the ground level will be an assessed level ground level as shown on the following diagrams:

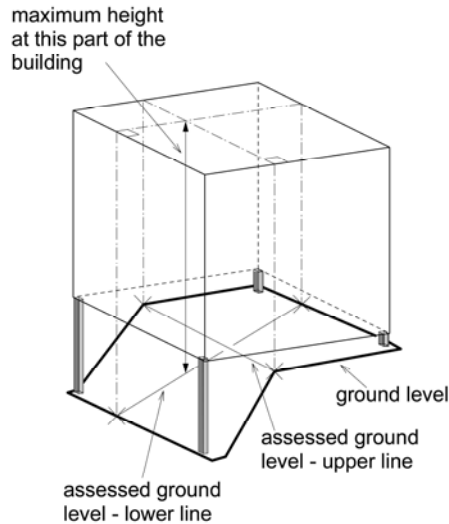
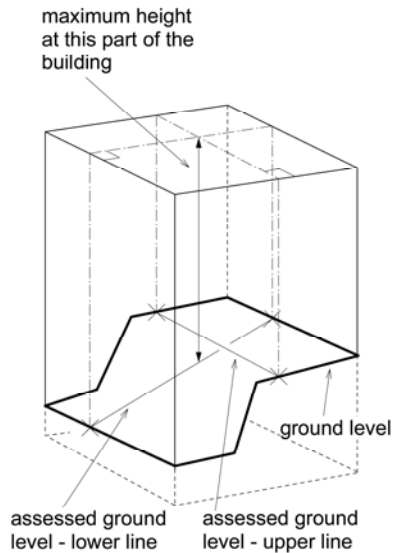

Where a different assessed ground level can be derived by using another line under the building at right angles to the first, the lower of the two assessed ground levels will be used for calculating maximum height.

- where there is visible evidence that the ground level on the boundary of the site has been altered by earthworks and the altered ground level has not been approved in association with a subdivision (at any date) or by a land use consent since July 1994, then ground level shall be an assessed ground level as shown on the following diagrams:

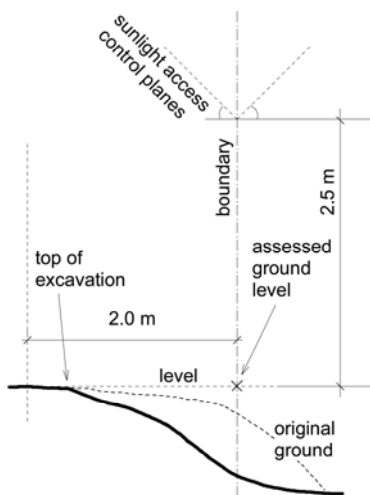

Where the top of the excavation is within 2 metres of the boundary, the assessed ground level at the boundary will be taken from the top of the excavation.

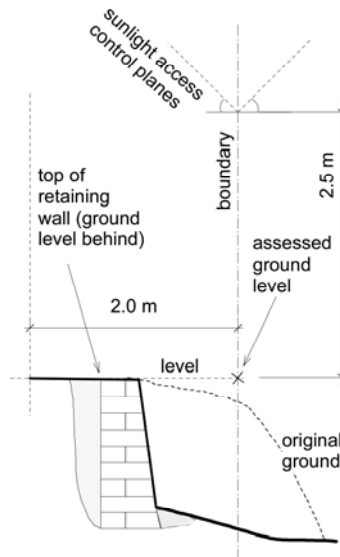

Where the retaining wall supports cut ground, and the ground level behind the top of the retaining wall is within 2 metres of the boundary, the assessed ground level at the boundary will be taken from the ground level behind the top of the retaining wall.

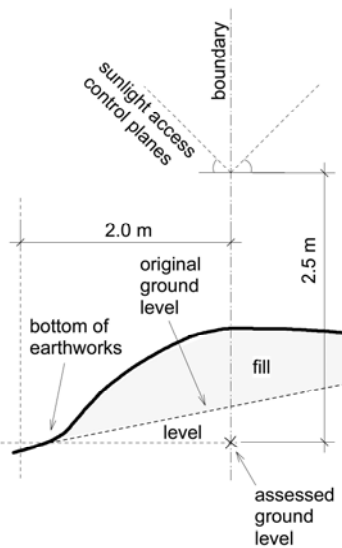

Where the original ground has been raised by earthworks, and the bottom of the earthworks is within 2 metres of the boundary, the assessed ground level at the boundary will be taken from the bottom of the earthworks.

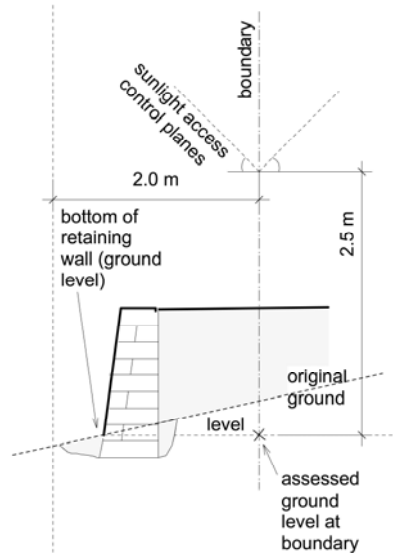

Where the retaining wall supports fill material, and the ground level at the bottom of the retaining wall is within 2 metres of the boundary, the assessed ground level at the boundary will be taken from the ground level at the bottom of the retaining wall.

Most ground levels will be taken from the existing ground level. An assessed level will be used for calculating maximum height where a building covers the ground. An assessed ground level will also be used for ground level on the boundary when the original level has been altered by earthworks not approved with a subdivision or by a land use consent since 1994 (which expressly approved earthworks on the boundary). The assessed level will be taken from the top or bottom of the earthworks or beside a retaining wall, as shown in the above diagrams.

The District Plan generally permits earthworks of 2.5 metres, without resource consent. While this does not prevent earthworks on a boundary, the ground level definition does not recognise these earthworks. Where permitted earthworks have altered the level an assessed ground level will be used, which will be taken from the top or bottom of the earthworks or beside a retaining wall, as shown in the diagrams above.

Where a building is located on top of a boundary the sunlight access plane will be calculated from the ground level at the boundary, which will vary depending on the circumstances.]^{PC6}

[HABITABLE ROOM: in any of the categories of activity referred to in the definition of ‘noise sensitive activity’, means a space within a building that is commonly associated with domestic living, but excludes any bathroom, laundry, water-closet, pantry, walk-in wardrobe, corridor, hallway, lobby, clothes-drying room, any room in an early childhood centre not used for sleeping, or other space of a specialised nature occupied neither frequently nor for extended periods of time.]^{PC23}

HAZARDOUS FACILITY: any [building, structure or activity on a site, or part of a]^{PC35} site where hazardous substances are stored, used, handled or disposed.

[HAZARDOUS SUB-FACILITY: a hazardous facility on part of a site that is separated by more than 30m from another hazardous facility on the same site.]^{PC35}

HAZARDOUS SUBSTANCE: has the same meaning as defined by S2 of the Hazardous Substances and New Organisms Act 1996.

HAZARD AREA: means an area of land subject to one or more hazards specifically identified on the District Plan Maps.

HEIGHT: means in relation to a building [or structure]^{PC6} the vertical distance between any part of [that]^{PC6} building [or structure]^{PC6} and the ground level [immediately below,]^{PC6} or mean sea level where specified [in this plan. This calculation is subject to:

- In Residential and Rural Areas an additional 1m can be added to the maximum height (stated in the rules) of any building with a roof slope of 15 degrees or greater as illustrated on the following diagram:

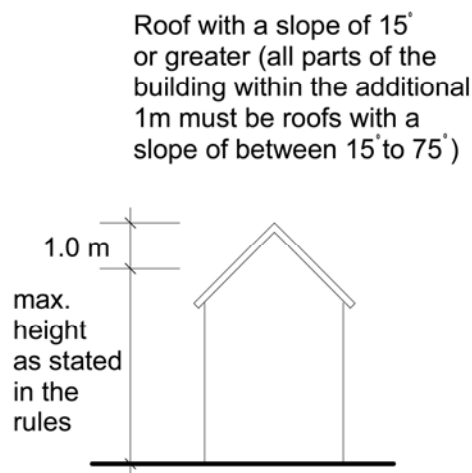

(though this allowance shall not apply in the Oriental Bay Height Area)

- the calculation of ground level in relation to any building or structure built lower than the existing ground level is outlined in the definition of ‘ground level’]^{PC6}
- Where height is measured in relation to storeys, the maximum floor to floor height per storey is 4.2 metres, except that the ground floor may have a maximum height of 6 metres
- In all cases, chimneys, flues, ventilation shafts, aerials, spires, flag-poles or other decorative features, [that do not exceed 1 metre in any horizontal direction,]^{PC6} shall be excluded from the measurement of height.

HERITAGE ITEMS: buildings, objects, areas, trees and sites of significance to Tangata Whenua or other Maori that are listed in the Plan.

HIRE SERVICES: means a business engaged in the direct hire of equipment to the public, excluding the hire of books, DVDs and videos.

HOUSEHOLD UNIT: means [a home or residence that:

- is a self-contained unit; and
- includes kitchen and bathroom facilities of any nature; and
- is physically separated, or capable of being separated, from any other household unit.]^{PC6}

[IDENTIFIED RIDGELINES AND HILLTOPS: means all of the land [within those areas identified as ridgelines and hilltops in the overlay on the planning maps.

Note: In 2001 Council undertook a city wide study (Wellington’s Ridgetops and Hilltops: The Natural Amenity Values, Boffa Miskell) to identify which ridgetops and hilltops should be afforded greater protection than less prominent ridgetops and hilltops. The City Council adopted an overlay of “identified ridgelines and hilltops’ on the District Plan Maps.

The 2001 study was not an outstanding natural features and landscapes study. It did not focus on landforms such as coastal escarpments, shore platforms, coastal headlands or other important landscape features. While visual values were the primary factor in determining the identified ridgetops and hilltops other natural, recreational and heritage values were also recognised. Rules and assessment criteria specifically applicable to activities within the overlay apply in the Rural Area and a resource consent for a discretionary activity (unrestricted) will be required for buildings, structures and earthworks in these areas. The ridgelines and hilltops overlay also applies within areas of Open Space, Conservation and Residential and specific assessment criteria have been included in the relevant discretionary (unrestricted) rules.]^{PC33}

INDIGENOUS VEGETATION: means any species or generic variants of plants found naturally in New Zealand.

[INFILL HOUSEHOLD UNIT: for sites less than 800 meters squared in the Outer Residential Area means:

- In relation to a site already containing one household unit, the second unit on the site where it is located outside the footprint of the existing unit (ie. the site coverage of the household units will increase as a result of the proposed second unit)
- In relation to a vacant site, where the proposed development results in two household units, the unit nominated by the applicant.]^{PC56}

INTEGRATED RETAIL DEVELOPMENTS: means an individual retail development, or a collection of any two or more retail activities that are developed and operate as a coherent entity (whether or not the activities are located on separate legal titles), and share one or more of the following:

- servicing and/or loading facilities;
- vehicle and/or pedestrian access;
- car parking;
- public spaces and/or facilities.

This definition includes shopping malls and large-format retail parks.

LANDFILL: means an area used for the disposal of waste (including inert material) into or onto land.

LARGE FORMAT RETAIL: means any individual retail activity exceeding 450m² gross floor area.

LIFELINES: means those services, linkages and infrastructure which the community depends on to function and develop. These include water supply, drainage (sanitary and stormwater), gas, electricity, telecommunications, broadcasting, transport (road, rail, sea and air), fire, police, and ambulance.

[LIGHT ROOF: means a roof with roofing material (cladding and any sarking), having a mass not exceeding 20kg/m² of roof area. Typical examples are steel, copper, and aluminium roof claddings of normal thickness, 6mm thick cellulose

cement tiles, 6mm thick corrugated cellulose cement, and the like, without sarking.]^{PC22}

[LIGHT WALL CLADDING: means a wall cladding having a mass not exceeding 30kg/m². Typical examples are weatherboards.]^{PC22}

LINE: as used in Part 23 of the Plan: Utility Rules means a wire or wires or a conductor of any kind (including a fibre optic or other cable) used or intended to be used for telecommunication; or the conveyance of electricity and includes any pole, support structure, pole mounted transformer, overhead substation, insulator, casing, minor fixture, tunnel or other equipment or material used or intended to be used for supporting, enclosing, surrounding, or protecting any such wire or conductor; and also includes any part of a line. Any reference to ‘overhead line’ includes any line above ground. [Any reference to ‘attached line’ is any wire or wires or conductor of any kind, located above ground, that is fully attached to the exterior of a building or structure.]^{PC14}

LOADING AREA: means that part of a site within which all vehicle loading facilities required under this Plan or otherwise provided, are accommodated and includes all loading spaces and manoeuvring areas.

MAST: means any pole, tower or similar structure, which is fixed to the ground (and not on a building or structure) and is designed to carry aerials, antennas or other utility network apparatus, but does not include any line.

MEAN HIGH WATER SPRINGS (MHWS): means the average of each pair of successive high waters during that period of approximately 24 hours in each semi-lunation when the range of tides is the greatest.

[MINOR RURAL STRUCTURE: means a structure associated with rural activities including fences of any height and other structures under 1.8 metres in height.]^{PC33}

MINOR UPGRADING: for the purposes of rule 23.1.3 means an increase in the carrying capacity, efficiency or security of electricity and telecommunication lines, which utilise the existing or replacement support structures and includes:

- (1) the reconductoring of the line with higher capacity conductors
- (2) the resagging of conductors
- (3) the addition of longer and more efficient insulators
- (4) on electricity lines above a carrying capacity of 66kV, the addition of earth wires which may contain telecommunication lines, earthpeaks, and lightning rods
- (5) the replacement of an existing line with another line
- (6) the addition of a polemounted transformer up to 200kVA no greater than .3m³ in Areas where there are existing overhead 11kV lines as at 27 July 1994 and other overhead electricity reticulation line equipment no greater than .3m³ where they are located on support structures.

Provided that the effects of the work in items (1) to (5) have the same or similar character and scale.

Except as provided above minor upgrading shall not include:

- (1) the addition of circuits, conductors, lines or utility structures

- (2) an increase in the voltage of the line unless the line was originally constructed to operate at the higher voltage but has been operating at a reduced voltage
- (3) an increase in the diameter of any individual wire, cable, or other similar conductor that exceeds 30mm, or the bundling together of any wire, cable, or other similar conductor so that the bundle exceeds 30mm, provided that this exclusion does not apply to electricity lines above a carrying capacity of 66kV.

MURAL: means an image, painting or drawing on a building or structure which is intended for public interest and has no direct or implied advertising, or advertising content.

NATURAL HAZARD: means any atmospheric or earth or water related occurrence (including earthquake, tsunami, erosion, volcanic and geothermal activity, land slip, subsidence, sedimentation, wind, drought, fire or flooding) the action of which adversely affects or may adversely affect human life, property, or other aspects of the environment.

NIGHT CURFEW EXEMPTION CERTIFICATE: means a certificate issued by the Wellington City Council to the effect that the single event noise level of the stated aircraft type (and configuration) has been measured at Wellington International Airport and has been able to adequately demonstrate that it creates no more than 75 dBA Lmax (1 sec Leq time-weighting) at or beyond the airnoise boundary during a minimum of 10 landings and/or departures. A list of night curfew exempt aircraft shall be compiled and copies of the approved list will be maintained by WIAL with copies held at Wellington City Council offices for public inspection.

~~**NOISE EMISSION LEVEL:** means the noise level measured and assessed in accordance with NZS 6801: 1991 "Measurement of Sound" and NZS 6802: 1991 "Assessment of Environmental Sound", except as expressly provided for in this Plan.~~

In addition:

- ~~• The assessment of cumulative effect of activities (with the exception of road traffic noise) shall be determined. Measurement of noise shall be made in such a way that as far as reasonably practical, the contribution of individual activities creating the noise shall be identified.~~

- ~~• Measurement time intervals shall be selected in accordance with paragraph 5.1 NZS 6802 : 1991 "Assessment of Environmental Sound" and the duration of measurement shall be sufficient to be representative of the range and variability of the sound environment. At night, single measurements shall be adequate to demonstrate non-compliance with a noise limit. At other times, the number of measurements taken shall be no less than three and shall accurately represent the variation in the sound or sounds. The number of measurements will often need to be more than three.~~

~~Where measurements are made at night they shall not be averaged for comparison with night time limits but each measurement compared separately. The measured levels for other time periods shall be averaged to derive a single figure according to the constraints detailed in NZS 6802 : 1991 paragraph 4.5.2 and assessed in accordance with that paragraph.~~

- ~~• In circumstances where the noise from any activity has special audible characteristics the L10 limits shall be reduced arithmetically by 5dB for comparison with the measured L10 descriptor of the~~

~~noise. No relevant performance standard L10 descriptor shall be reduced overall by more than 5dB.~~

- ~~• The following activities and specific noise sources are not appropriately controlled using assessment by NZS6802:1991 Assessment of Environmental Sound and noise rules in this Plan, unless the rule states to the contrary:~~

~~— vehicles driven on a road (within the meaning of s.2(1) of the Transport Act 1962) or vehicular movements on any sites which are in keeping with normal residential activity~~

~~— the operation of aircraft including helicopters, at Wellington International Airport and airborne aircraft elsewhere throughout the District.~~

- ~~• High energy impulsive sounds such as gunfire, blasting and warning devices are not adequately controlled using assessment by NZS6802:1991 Assessment of Environmental Sound and noise rules in this Plan, unless the rule states to the contrary.~~

~~Noise from high energy impulsive sounds are not adequately controlled using the current New Zealand Standards. Activities that emit noise with such characteristic are generally likely to cause greater annoyance than assessment using Rules within this Plan would indicate. The impact of such activities would be assessed by reference to Section 16(1) of the Resource Management Act.~~

- ~~• Noise from construction, maintenance and demolition activities, including those associated with the urgent repair of utilities to maintain continuity of service, on any site or on any road shall comply with, and be measured and assessed using, the recommendations of NZS6803P:1984 The Measurement and Assessment of Noise from Construction, Maintenance and Demolition Work. Nothing in the noise rules shall be used to prevent emergency work from taking place. Such work would arise from the need to protect life or limb or minimise or prevent loss or serious damage to property or minimise or prevent environmental damage.~~

- ~~• Where in noise rules in this Plan, the noise emission limit applies “at or within the boundary of any site, other than the site from which the noise is generated” then neither shall the noise standard apply at or within the boundaries of any other site included in the parcel of land that incorporates the site from which the noise is generated, provided that:~~

~~— all sites in the parcel of land are held under the same ownership or under the same management~~

~~— to be considered part of the parcel of land each site shall remain contiguous with at least one other site in the parcel that is under the same ownership.~~

NOISE EMISSION LEVEL: means the noise level measured and assessed in accordance with NZS 6801: 2008 “Acoustics - Measurement of Environmental Sound” and NZS 6802: 2008 “Acoustics - Environmental Noise”, where this Plan or conditions of consent refer to the LAeq(15min) descriptor and in accordance with NZS 6801: 1991 “Measurement of Sound” and NZS 6802: 1991 “Assessment of Environmental Sound” where this Plan or conditions of consent refer to the L(10) descriptor, except as expressly provided for in this Plan.

In addition:

- The assessment of cumulative effect of activities (with the exception of road traffic noise) shall be determined. Measurement of noise

shall be made in such a way that as far as reasonably practical, the contribution of individual activities creating the noise shall be identified.

- The following activities and specific noise sources are not appropriately controlled using assessment by either NZS 6802: 2008 “Acoustics - Environmental noise” or NZS6802:1991 “Assessment of Environmental Sound” and noise rules in this Plan, unless the rule states to the contrary:
 - vehicles driven on a road (within the meaning of s.2(1) of the Transport Act 1962) or vehicular movements on any sites which are in keeping with normal residential activity
 - the operation of aircraft including helicopters, at Wellington International Airport and airborne aircraft elsewhere throughout the District.
- High energy impulsive sounds such as gunfire, blasting and warning devices are not adequately controlled using assessment by either NZS 6802: 2008 “Acoustics - Environmental noise” or NZS6802:1991 “Assessment of Environmental Sound” and noise rules in this Plan, unless the rule states to the contrary.

Noise from high energy impulsive sounds are not adequately controlled using the current New Zealand Standards. Activities that emit noise with such characteristics are generally likely to cause greater annoyance than assessment using Rules within this Plan would indicate. The impact of such activities would be assessed by reference to Section 16(1) of the Resource Management Act.

- Noise from construction, maintenance and demolition activities, including those associated with the urgent repair of utilities to maintain continuity of service, on any site or on any road shall comply with, and be measured and assessed using, the recommendations of NZS6803P:1984 The Measurement and Assessment of Noise from Construction, Maintenance and Demolition Work. Nothing in the noise rules shall be used to prevent emergency work from taking place. Such work would arise from the need to protect life or limb or minimise or prevent loss or serious damage to property or minimise or prevent environmental damage.
- Where in noise rules in this Plan, the noise emission limit applies “at or within the boundary of any site, other than the site from which the noise is generated” then neither shall the noise standard apply at or within the boundaries of any other site included in the parcel of land that incorporates the site from which the noise is generated, provided that:
 - all sites in the parcel of land are held under the same ownership or under the same management
 - to be considered part of the parcel of land each site shall remain contiguous with at least one other site in the parcel that is under the same ownership.

Existing uses that are established before the Plan became notified may emit noise that exceeds the noise emission standards in the District Plan. The Resource Management Act provides for these activities to continue as long as the uses are the same or similar in character, intensity, and scale to those which existed before the rule became operative or the proposed plan was notified. Any change to the activity that causes a worsening of the effects will require a resource consent. This does not remove the duty placed on every occupier and every person carrying out an activity to adopt the best practicable option to ensure that the emission of noise does not exceed a reasonable level.

[NOISE SENSITIVE ACTIVITY: means

- any residential activity
- any hotel, motel or other premises where residential accommodation for five or more travellers is offered at a daily tariff or other specified time
- early childhood centres]^{PC23}

OFFICE FURNITURE, EQUIPMENT AND SYSTEMS SUPPLIES: means a business primarily engaged in selling goods for office type use or consumption, and includes suppliers of computers, copiers, printers, office furniture and other related equipment.

OFFICIAL SIGN: means all regulatory traffic and road safety signs provided for under any legislation and other directional signals and which are erected on a legal road or motorway. It also includes New Zealand Automobile Association Incorporated directional signs.

OPEN LAND: means any land (whether or not located in Open Space A, B or C areas) which is developed for recreation or amenity activities that do not take place in buildings.

PARKING AREA: means that part of a site or building within which vehicle parking spaces are accommodated and includes all manoeuvring areas.

PARKING SPACE: means an area formed and set aside exclusively for the parking of motor vehicles to meet the parking standards of this Plan. Where parking standards involve decimal places, calculated totals shall be rounded to the nearest whole number.

PLACES OF ASSEMBLY: means any building or land used for public and/or private assembly or meeting of people and includes churches, halls, clubrooms, community centres, conference centres, chartered clubs and premises with a club licence and other similar establishments, including indoor and outdoor recreation facilities, such as gymnasiums, badminton and squash courts.

PLAN OR DISTRICT PLAN: means the District Plan for Wellington City (operative or proposed) and includes:

- Volume 1: Objectives, Policies and Rules;
- Volume 2: Design Guides; and
- Volume 3: District Plan Maps.

[PORT NOISE AFFECTED AREA: means the Inner Port Noise Affected Area or the Outer Port Noise Affected Area as shown on the planning maps.

PORT NOISE CONTROL LINE: means the line at or beyond which the rules controlling the emission of noise from Port Related Activities apply and where the noise from Port Related Activities is monitored.

PORT RELATED ACTIVITIES (FOR THE PURPOSE OF RULES AND STANDARDS RELATING TO PORT NOISE): means activities within the Operational Port Area, the Port Redevelopment Precinct and adjacent Coastal Marine Area including the berthing, departure and movement of ships, storage and cargo handling, handling of goods and passengers, all activities associated with the movement, storage and handling of cargo and any activities (including construction, maintenance and repair) associated with buildings, machinery and equipment used in connection with the port or its administration. Activities not directly connected to the operation of the port such as office activities, retail activities, and other non-port uses within the Operational Port Area and Port Redevelopment Precinct are excluded.]^{PC49}

[PRIMARY ELEVATION(S) (FOR THE PURPOSE OF BUILDINGS IN NEWTOWN, BERHAMPORE, MT COOK AND ARO VALLEY – REFER APPENDIX 9 TO CHAPTER 5 OF THE PLAN): means the elevation(s) of a building that contribute to the historical architectural character of the streetscape and neighbourhood. The primary elevation is the dwelling’s most prominent and detailed elevation.

The primary elevation is usually the elevation (or elevations in the case of a corner sites) that fronts to the street. There are three areas where the building’s main elevation has been orientated away from the street towards a view or outlook. These properties (identified in Appendix 9) front onto Kerwyn Street, Tasman Street and Wright Street. For the Tasman Street properties both the street elevation and the rear elevation are considered to be primary elevations. For the Kerwyn Street and Wright Street properties only the rear elevations are primary elevations.

The primary elevation consists of all those features that contribute to the form and style of the building, including but not limited to:

- materials,
- detailing,
- window/wall ratios,
- architectural features and elements such as bay windows, verandahs, porches, turrets or steps.]^{PC38}

PRIMARY FORM (FOR THE PURPOSE OF RULE 5.3.11): means the simple form that is central to and the basis of the dwelling. It is typically the largest identifiable form or combination of relatively equal sized geometrically simple and box-like forms.

Primary Form Diagrams

- Solid line indicates primary form
- Broken line indicates secondary or tertiary form
- Examples drawn are indicative rather than comprehensive in scope

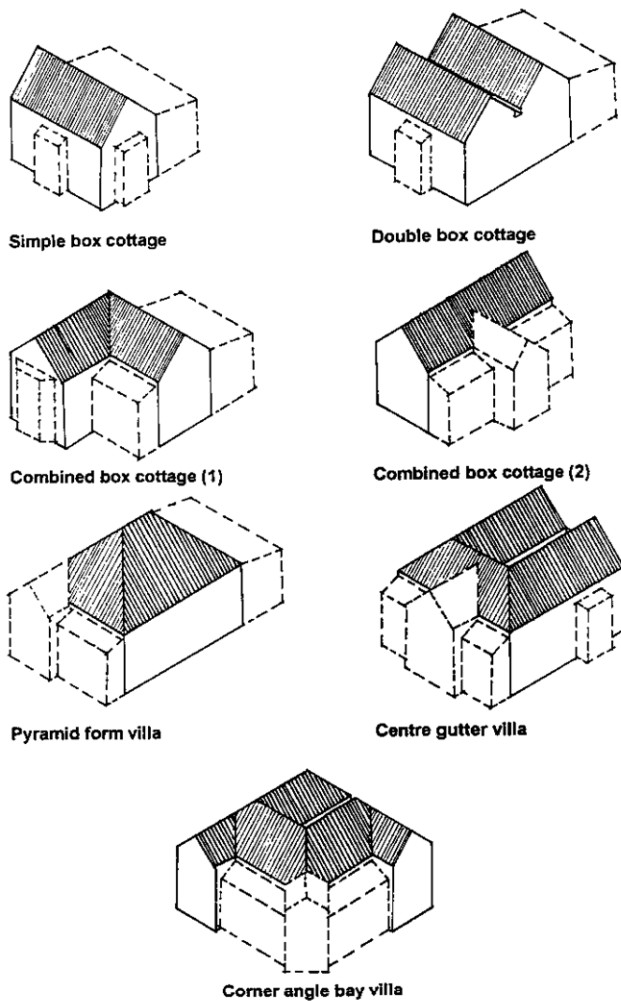

[PUBLIC ACCESSWAY: an area of land, set aside as a passage way for pedestrian access between a road, service lane, reserve, railway station or public place; and another road, service lane, reserve, railway station or public place.]^{PC6}

PUBLIC SPACE: means those places in public or private ownership which are available for public access (physical or visual) or leisure and that are characterised by their public patterns of use. Public spaces include, but not limited to, streets, accessways, squares, plazas, urban parks, open space and all open or covered spaces within buildings or structures that are generally available for use by the public, notwithstanding that access may be denied at certain times.

RECREATION ACTIVITY: means any activity whose primary aim is the passive or active enjoyment of leisure, whether competitive or non-competitive, casual or organised, (but does not include the use of motor vehicles in Conservation Sites or Open Space Areas). Recreation has a corresponding meaning.

REGIONALLY SIGNIFICANT CENTRE: the regionally significant centres are:

- Central Business district in Wellington City
- Upper Hutt city centre
- Lower Hutt city centre
- Masterton
- Porirua city centre
- Paraparaumu town centre
- Petone
- Kilbirnie
- Johnsonville

REGIONALLY SIGNIFICANT CENTRE: has the same meaning as in the Proposed Regional Policy Statement for the Wellington Region.

REPAIR AND MAINTENANCE (FOR THE PURPOSES OF CHAPTERS 20 AND 21) includes:

- (i) in the case of the interior of a building, any alteration or addition to or demolition of a non-structural interior element, unless that element is identified on the heritage list as being of heritage significance
- (ii) any repair of a structural element that substantially preserves or recreates either the original structural appearance or the structural appearance on 27 July 1994
- (iii) any repair (including the replacement of any element reasonably required to maintain the building in a sound or weather proof condition or to prevent deterioration of the building fabric) using the same materials or materials of similar texture, form profile and strength

but does not include:

- (iv) in the case of a building, any other alteration of addition to or demolition of any structural element
- (v) in the case of the exterior of a building, any other repair of a structural element.

And for the purposes of this definition:

“structural” in relation to any building means any facade, any exterior wall, any roof, and any internal load bearing walls; and

“non-structural” has a corresponding meaning.

[REPAIR OR MAINTENANCE (FOR THE PURPOSE OF PRE-1930 BUILDINGS IN [ARO VALLEY]^{PC50}, NEWTOWN, BERHAMPORE AND MT COOK – REFER APPENDIX 9 TO CHAPTER 5 OF THE PLAN) includes:

- (i) any repair that substantially preserves or recreates the original structural appearance and materials of the buildings main elevation(s).
- (ii) any repair (including the replacement of any element reasonably required to maintain the building in a sound or weather proof condition or to prevent deterioration of the building fabric) using the same materials or materials of similar texture, form, profile and strength.

but does not include:

- (iii) any demolition of any structural element.

For the purpose of this definition:

‘structural’ in relation to any building means any façade or exterior wall.]^{PC50}

RESIDENTIAL ACTIVITY: means the use of premises for any domestic or related purpose by persons living in the premises alone or in family and/or non-family groups (whether any person is subject to care, supervision or not), but does not include work from home, hotels, motels, camping grounds, motor camps or other premises where residential accommodation for five or more travellers is offered at a daily tariff or other specified time.

RESIDENTIAL BUILDING: means a building, containing [part of a household unit (for example, a sleep-out)]^{PC6}, one household unit or more [than one]^{PC6} household unit; used or intended to be used [for]^{PC6} a residential activity.

[RESIDENTIAL STRUCTURE: means a structure used or intended to be used in association with a residential activity.]^{PC6}

~~**RETAIL ACTIVITY:** means an activity displaying or offering services or goods for the sale or hire to the trade or public and includes, but is not limited to: integrated retail developments, trade supply retail, yard based suppliers, supermarkets, service retail, and ancillary retail.~~

RETAIL ACTIVITY: means an activity displaying or offering services or goods for the sale or hire to the trade or public and includes, but is not limited to: integrated retail developments, trade supply retail, yard based retail, supermarkets, service retail, and ancillary retail.

ROAD HIERARCHY: means the classification of roads as follows and as shown in District Plan Maps 33 and 34.

- Motorway: high standard limited access roads designed to carry long distance through traffic at speed (primary road).
- Arterial Road: high standard limited access roads designed to carry long distance through traffic (primary road).
- Principal Road: roads that provide access to motorways and to arterial roads having a dominant through-traffic function and carrying the major public transport routes (primary road).
- Collector Road: roads that distribute traffic between and within local areas and form the link between principal and secondary roads (secondary road).
- Sub-collector Road: roads that distribute traffic within the local area and form the link between collector and local roads (secondary road).
- Local Road: roads that provide direct access to properties fronting the road and include both long and short cul-de-sacs (secondary road).

RURAL ACTIVITY: means primary production activities including horticulture, silviculture, and pastoral farming, but excluding top soil stripping, turf farming and quarrying.

SCULPTURE: means a three-dimensional artwork which is intended for public interest and has no direct or implied advertising, or advertising content.

SENSITIVE ENVIRONMENTS: (USED IN THE HFSP ANALYSIS OF A HAZARDOUS FACILITY) means those areas which are:

- within 20m of a waterbody
- mapped as a Conservation Site
- mapped Open Space

Sensitive environments will require additional buffer zones from activities involving the use, storage, handling or disposal of hazardous substances.

SENSITIVE ACTIVITIES AND USES: (USED IN THE HFSP ANALYSIS OF A HAZARDOUS FACILITY) means those activities and uses which are:

- schools, kindergarten or child care centres
- homes for the elderly, hospitals, residential care facilities, premises with high density, low mobility uses

- facilities critical to emergency response and utility lifelines
- transport corridors to emergency services
- residential activities (applies only in Central Area, and ~~Suburban Centres and Business Areas~~)

Sensitive activities and uses will require additional buffer zones from activities involving the use, storage, handling or disposal of hazardous substances.

SERVICE RETAIL: means the sale of served food and/or beverages, and/or services such as, but not limited to video and DVD hire, dry cleaners, takeaway food outlets, cafés, pubs, bars, hairdressers and beauticians and banks.

SIGN: means any name, figure, writing, image, character, outline, engraving, carving, spectacle, logo, display, delineation, announcement, notice, placard, poster, handbill, hoarding, billboard, aerial display, banner, advertising device or appliance, or any other things of a similar advertising nature, intended principally to attract the attention of the public and has implied or actual commercial advertising content, whether it is placed on or affixed to any land or building, or incorporated within the design of any building (whether by painting or otherwise) which is visible from a public space. ~~This excludes signs within buildings and signs for the management of the legal road.~~ This definition excludes:

- Signs within buildings
- Signs for the management of the legal road, public parks and reserves including official signs
- Advertising on vehicles, including trailers, except where the vehicle or trailer acts as a stationary support structure for commercial advertising
- Murals
- Sculptures

SIGN AREA: means the entire area within a continuous perimeter enclosing the extreme limits of lettering, framework or emblem, together with any material or colour forming an integral part of the display or used to differentiate such a sign from the background against which it is placed.

SITE: means any area of land comprised wholly in one certificate of title or any allotments as defined by the Act, or any allotments linked pursuant to the provisions of section 37 of the Building Act 1991.

SITE AREA: means the total area of a site, [but excludes:]^{PC6}

- any part of the site subject to any proposed road widening
- any designation for a public work
- [the area of any access lot or access strip [that provides access to the site or to another site.]]^{PC6}

For the purpose of calculating site coverage on any allotment resulting from the subdivision of Lot 2 DP 85339 at 54 Weld Street, and Lot 2 DP 40924 at 164 Ohiro Road, site area includes any site access strip defined by a legal instrument (for example, a right of way).]^{PC6}

SITE COVERAGE: means that portion of the site area [that]^{PC6} may be covered by buildings and structures but does not include:

- eaves 1 metre or less in width
- [pergola structures that are not covered by a roof, trellis or other overhead covering
- fences and walls

- minor structures such as letterboxes, clotheslines and children’s play equipment]^{PC6}
- uncovered decks less than 1 metre above ground level
- [terraces of any height
- paths, driveways and other paved surfaces on the ground
- any part of a building or structure where the walls (of that part) are located below the surface of the ground, provided that the roof (of that part) does not project above the finished ground at the completion of the building or structure.

Note: Garages set completely into the ground, with only doors opening onto a driveway or street, are excluded from site coverage.]^{PC6}

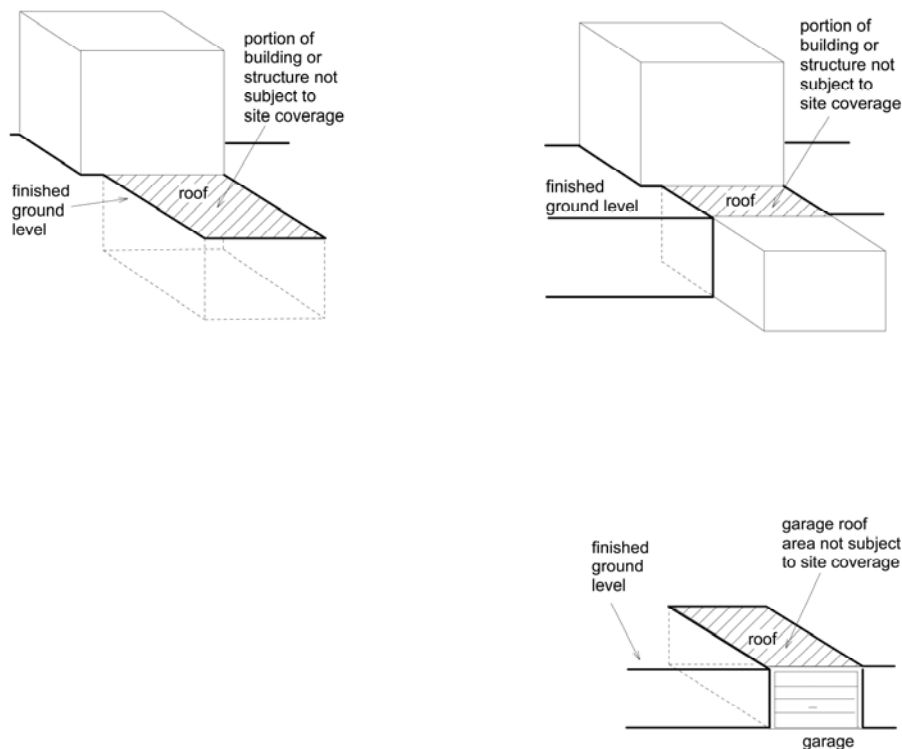

Diagrams added by Plan Change 6

[SOLAR ENERGY: means the generation of electricity through the use of photovoltaic panels and the direct transmission of heat from the sun for the heating of water and/or other building spaces.]^{PC32}

SPECIAL ENTERTAINMENT EVENT: means temporary activities which generate noise levels above those provided for by Permitted Activity condition 13.20.1.1 'Noise - General activities', and generally relates to activities such as music concerts and events using amplifiers and public address systems, including sound testing of equipment associated with such an activity, but excluding sporting events.

STOREY: means a floor (full or mezzanine) or level of a building including the ground floor level. Where height is measured in relation to storeys, the maximum floor to floor height per storey is 4.2 metres, except that the ground floor may have a maximum height of 6 metres.

STREETSCAPE (FOR THE PURPOSE OF RULE 5.3.11): means the collective image of buildings and their relationship to each other and to the street (including, but not limited to rights of way, pedestrian routes etc).

[STRUCTURE: means any equipment, device, or other facility made by people and which is fixed to the land; and includes fences and walls. For the purposes of the District Plan, this definition excludes any building.]^{PC6}

SUPERMARKET: means a retail shop selling a wide range of foodstuffs, including fresh produce, meat, fish, dairy, alcoholic and other beverages, and packaged food for consumption off-site, as well as non-food grocery items and household goods. This definition includes discount stores, hypermarkets, department stores and warehouse club stores, where foodstuffs comprise more than 10% of the total gross floor area.

TAKAPU HAZARD (FLOODING) AREA: means an area of land adjacent to the Takapu Stream and identified on the District Plan Maps 29 and 30 as being prone to flooding.

TAWA HAZARD (FLOODING) AREA: means an area of land adjacent to the Porirua Stream in the Tawa and Glenside Road/Middleton Road areas, and shown on the District Plan Maps 26, 29, 30 and 31 as being prone to flooding during a 1 in 100 year flood event.

TECHNOLOGICAL HAZARDS: means the accidental failure of the design or management of large scale infrastructure, transport systems, or industrial activities which would present life-threatening risks to the local community, or adversely affect property or other aspects of the environment.

TEMPORARY ACTIVITY (IN RESPECT OF ALL CHAPTERS OTHER THAN CHAPTER 23): means an activity that is of a non-repetitive, transient nature and includes entertainment, cultural and sporting events that are of less than three days' duration and that do not involve permanent structures.

TEMPORARY ACTIVITY (IN RESPECT OF CHAPTER 23 ONLY): means any utility network infrastructure to maintain the general capability of a telecommunications, radiocommunication or electricity network that is used for no more than 4 weeks or used to provide network utility services for periods of increased demand such as entertainment, sporting and cultural events, or construction activities.

[TEMPORARY ACTIVITY (IN RESPECT OF THE LAMBTON HARBOUR AREA): means temporary activities are activities and events that are of less than one month's duration.]^{VAR22}

TEMPORARY SIGN: means any sign erected and removed in relation to:

- advertising a community event
- electioneering
- identifying construction sites or subdivision developments
- selling land or premises.

TEMPORARY STORAGE: storage for any period of time less than 24 hours.

[TERRACE: an area of ground that is grassed or paved and is used or is intended to be used for outdoor living.]^{PC6}

THE GOLDEN MILE: means properties that either front or gain access from the main retail and commercial strip extending from the Cenotaph (near Parliament Buildings) to the eastern end of Courtenay Place (see Map 34, Volume III).

THIRD PARTY ADVERTISING: means any land, building, fence, structure or erection upon or against which any advertisement, placard, sign or inscription is displayed by an independent manufacturer, corporation, business, sponsor, service company, retailer, supplier or other party which is used to advertise anything not sold or provided on the premises where such sign is situated, or advertises an event to take place in some other location.

TRADE SUPPLY RETAIL: means a business engaged in sales to businesses, and may also include sales to the general public, and wholly consists of suppliers of goods in one or more of the following:

- automotive and marine supplies;
- building supplies;
- farming and agricultural supplies;
- garden and landscaping supplies;

- hire services (excluding hire of books, DVD and video);
- office furniture, equipment and systems supplies.

TRANSPORT INTERCHANGE AREA: areas designed for the interchange of goods and products between transport modes or carriers, and includes those parts of airports, ports, railyards and freight, courier and postal depots, designed for that purpose.

UTILITY NETWORK: means network utility operations as defined in Section 166 of the Act and for the purposes of this Plan also includes lighthouses, navigation and survey aids and beacons and meteorological installations.

UTILITY NETWORK APPARATUS: means any apparatus or device that is mounted on a mast and used as part of a utility network but excludes any aerial, antenna or line.

UTILITY STRUCTURE: means any structure associated with a network or that receives or transmits to or from any part of a utility network operation and includes pipes, pipelines, valves, meters, regulator stations, transformers (other than a pole mounted transformer), substations (other than an overhead substation), compressor stations, pumping stations, navigational aids, meteorological installations, telephone booths, containers, cabinets, and similar structures, whether for private or public purposes. It does not include lines, aerials, antennas, masts, utility network apparatus, and the generation of matter or energy transmitted by the network utility operation.

VACANT LAND: means any land which is not developed for any recreation, amenity, building or parking activity.

VEHICLE DEPOT: means any land or building used principally for the receiving, despatching or holding of goods or passengers by road.

~~**VEHICLE ORIENTATED USES:** means any retail activity which offers services or goods to the public on a drive through basis. This includes but is not limited to: service stations dispensing motor fuels, fast food outlets offering food to customers in vehicles, vehicle testing stations, and vehicle repairs and maintenance.~~

WATERBODY: has the meaning contained within the Act. For the purposes of this District Plan a waterbody's area is defined as the area which its water covers at its fullest flow or highest level, without overtopping its banks or margins.

[WELLINGTON WATERFRONT FRAMEWORK: means the Wellington Waterfront Framework adopted by Council on 3 April 2001.]^{VAR22}

WHOLESALE: means a business engaged in the storage and distribution of goods to businesses (including retail activities) and institutional customers.

[WIND ENERGY FACILITY: (colloquially, a 'wind farm') means the land, buildings, substations, turbines, structures, underground cabling earthworks, access tracks and roads associated with the generation of electricity by wind force and the operation of the wind energy facility. It does not include:

- Small scale turbines of less than 5kW
- Any cabling required to link the wind energy facility to the point of entry into the electricity network, whether transmission or distribution in nature.]^{PC32}

WORK FROM HOME: means an occupation, art, craft, business, trade or profession which is carried out in a residential building by a maximum of three persons, at least one of whom lives in that building as their principal place of residence, (apart from in the Inner Residential Area north of John Street/Hutchinson

Road where all workers shall reside on the premises). It does not include the repair or maintenance of motor vehicles or internal combustion engines (excluding the residents' motor vehicles).

YARD: means a part of a site unoccupied and unobstructed by buildings above ground level, excluding eaves.

- Front yard: means a yard between the road line and line parallel thereto and extending across the full width of the site provided that:
 - where part of the site is shown on the District Plan Maps as proposed road, the proposed road line shall, for the purposes of all front yard requirements, be substituted for existing road line
 - where there is a building line restriction shown in the District Plan then this line shall, for the purpose of all front yard requirements, be substituted for the existing roadline.
- Any yard, other than a front yard, means a yard between a boundary of the site and a line parallel thereto.

~~**YARD BASED RETAILING:** means any retail activity which supplies goods or services primarily from an open or semi covered yard, and where the yard comprises at least 50% of the total area used for retail activities. This includes but is not limited to: garden centres, automotive and marine supplies, agricultural supplies, heavy machinery and plant sales.~~

YARD BASED RETAIL: means any retail activity which supplies goods or services primarily from an open or semi-covered yard, and where the yard comprises at least 50% of the total area used for retail activities. This includes but is not limited to: garden centres, service stations, automotive and marine supplies, agricultural supplies, heavy machinery and plant sales.