

# GUIDELINES FOR DESIGN AGAINST CRIME – TABLE OF CONTENTS

1.0	Introduction	Page 2
	General Intention	2
	Background and Rationale	2
	Scope	3
	Structure	3
2.0	Design Elements	5
	Informal Surveillance	5
	Formal Surveillance	8
	Lighting	9
	Concealment	12
	Entrapment	14
	Robustness	16
	Maintenance	18

# 1.0 Introduction

## General Intention

Personal safety and security and freedom from crime is a critical component of the liveability of the city.

The general intention of this Design Guide is to reduce the opportunity for crime against both people and property in urban public space, and by reducing the opportunity for these crimes to occur, to reduce the fear of crime.

This will be achieved by applying the established principles of Crime Prevention Through Environmental Design (CPTED) to the design of relevant parts of all new development and alterations to existing buildings or public spaces.

This Design Guide is drawn from review of CPTED research, similar overseas initiatives and expert consultation.

## Background and Rationale

### Crime and the physical environment

While specific detailed features of the built environment do not cause crime, they do provide the setting for its occurrence. The detail of that setting can promote or inhibit criminal activity. The detailed physical features of a specific locality may affect the likelihood of certain types of crime occurring in that setting.

Some unpremeditated crimes may occur simply because a willing offender is presented with the opportunity to carry out a crime. However, much crime is carried out by people who already have a criminal intent. If someone intends to commit a crime, they usually choose conditions that offer the greatest chance of getting away with it.

There is evidence that a number of specific physical design or environmental characteristics are relevant to:

- increasing the offender's perceived and real risk of apprehension
- increasing the technical difficulty of committing a crime
- reducing both attempted and successful crimes
- increasing people's perception of their personal safety and security and reducing their fear of crime.

### CPTED Concepts

These objectives and the design guidelines intended to effect them are justified by reference to the theory and concepts of CPTED. Relevant concepts include:

- physically defining public space to encourage proprietorship, or "territoriality"
- considering the visual environmental quality, or "image and milieu"
- encouraging "eyes on the street", or "social surveillance"
- encouraging people to take responsibility or intervene when they see crime, or "community building"
- reducing through the design of the physical environment the potential for the use by criminals of its various features to control the victims of crime
- the use of "target hardening" hardware to make it technically more difficult to commit crime, and monitoring equipment and procedures to reduce the possibility of criminals escaping undetected from the scene of the crime.

## Scope

This Guide is specifically concerned with the design of urban public spaces. Urban public space is defined as all places of free public assembly and thoroughfare within suburban commercial centres and the central and inner areas of the city. As well as publicly owned streets and parks, it includes publicly accessible private property outside buildings and such private indoor facilities as carparking buildings where no formal separation between public and private space occurs.

## Focus

The guide deals exclusively with design of the small-scale, detailed elements at the frontages and base of a building rather than with the overall structure of the city, because that is the level at which the individual property owner or developer has direct control.

It relates to those parts of the city that are dominated by buildings rather than by nature, and which are used by night as well as by day. Such areas include designated and frequently used pedestrian routes, public carparks and publicly accessible private carparking buildings, and areas near shops, schools or other public facilities where many people congregate at various times during the day or night.

## Limits

The Design Guide does not deal with the detailed design that may be employed to improve safety and security inside private facilities or buildings other than those to which the public can gain uncontrolled access. Such semi-public zones to which the guide applies include carparks, plant-rooms, lifts and internal accessways.

## **Structure**

The Design Guide is based on important principles relevant to design against crime. Each principle is introduced by a brief statement of its relevance and the rationale for its inclusion, and the objectives and detailed guidelines follow this.

## 2.0 Design Elements

### Informal Surveillance

#### Analysis

Informal surveillance is the casual observation of activities and people in public and semi-public spaces by other people engaged in legitimate activity. Such observation may occur from inside buildings. In this case the placement of windows and doors, particularly at ground level, is important as is the location outdoors of people and activities relative to those wall openings. Alternatively, the casual observation may be from outside, with people on the street informally keeping an eye on the street and the people using it.

#### Eyes on the Street

Whether the surveillance is coming from inside or outside buildings, the strategy to reduce crime and the fear of crime is the same - to increase eyes on the street. More eyes on the street increases the likelihood that crime will be observed. Assuming that people are willing to act when they observe suspicious behaviour, either by reporting such behaviour or intervening directly, then informal surveillance may be expected to reduce the number of crimes in progress, provide evidence that may be used in investigation and prosecution and increase the citizen's sense of protection. It follows that by increasing the offender's perceived and real risk of being caught that, except for the most brazen and spontaneous crimes, the incidence of crime will be reduced.

#### Ownership

The level of proprietorial interest in public space is significant, and may affect people's willingness to act in response to crime. People are more likely to take responsibility for an area and what happens in it when they perceive it to be formally under their control or influence.

Publicly accessible and relevant private facilities and activity should be physically connected with public space. In fact, where space is available and other development criteria are met, such facilities and activity should be extended out into the street. Such use encourages not only eyes on the street but also occupation of the street and responsibility for the territory occupied.

Examples of uses could include terraces to pubs and restaurants, display areas for shops, residential balconies and any other legitimate uses that give vitality to and encourage occupation of the street. Factors to be considered to maximise surveillance include the timing and duration of street occupation and the provision of weather protection.

Informal surveillance targets crimes against people. It not only increases their actual safety, it helps them feel safer if they perceive that other people are keeping an eye on them.



## Graffiti

While increasing eyes on the street can reduce certain crimes, vandalism like graffiti tends to occur precisely where the maximum public exposure it depends on can be gained. Strategies such as prompt removal of graffiti and the use of vandal-resistant finishes and textures may be employed to discourage such crimes.

## Vulnerability

There is strong evidence that isolation and lack of informal surveillance increases an area's vulnerability to crime. Conversely, very heavy traffic can also increase that vulnerability because crowds inevitably conceal more potential offenders such as pickpockets and bag snatchers. What is important is not only how many pedestrians there are, but who they are.

Good visibility is critical to the success of informal surveillance as a crime prevention strategy.

## Objective

To maximise the opportunity for the informal surveillance of publicly accessible space in residential, commercial and public areas both by people in buildings nearby and people in public open space going about their normal daily activity.

## Guidelines

- G1** Building entrances and exits should face the street or be otherwise overlooked from occupied public space or adjacent buildings.
- G2** Locate windows from normally occupied rooms with a view over public space wherever possible.
- G3** Locate windows in street-level facades to allow casual observation of the street from occupied interior spaces. Avoid blank, windowless street-level facades.
- G4** Wherever possible, locate publicly relevant activities at the public edges of buildings with access to and a view out over public space.
- G5** Place windows from occupied spaces to overlook pedestrian routes, particularly those where movement can be predicted (such as pathways to parking lots of garages).
- G6** Where a street or public space is not already densely occupied or overlooked from other buildings, ensure that partitioning or window displays in ground- or first-floor windows do not prevent people inside from seeing what is happening on the street outside.

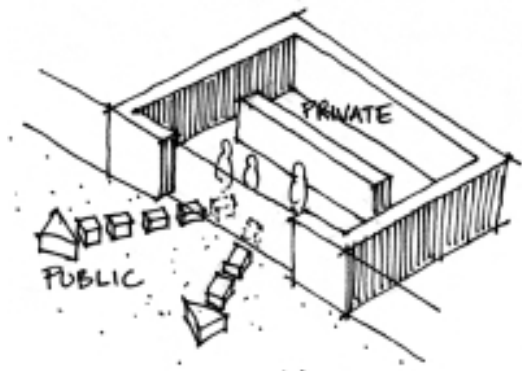

- G7** Ensure that barriers at the street edge such as walls or vegetation have sufficient gaps or transparency to allow people inside buildings to see out to the street while still satisfying the requirements of privacy or physical security for the occupants of the building.
- G8** Wherever it is consistent with other public and private objectives extend publicly accessible and relevant private facilities and activity out into public space.
- G9** Locate bus and taxi stops in well-used, well-lit public places so that people waiting can easily use facilities such as Automatic Transaction Machines (ATMs), toilets and public telephones, and can feel safe and comfortable doing so.

# Formal Surveillance

## Analysis

Formal surveillance is the organised or systematic supervision of a building or public space by other people whose prime task is maintaining security. Such people may include caretakers, receptionists and the police or private security firms.

Surveillance may use hardware such as cameras or alarms or result from a personal visit and overview. Surveillance is generally intended first to deter and detect crimes against people such as robbery or assault, and second to address the incidence of crimes against property, such as graffiti or vandalism.

### The Benefits of Formal Surveillance

Effective systematic surveillance of an area will increase the probability that a crime will be seen and that security personnel can intervene. Criminals may be deterred from carrying out a crime if they are aware that effective formal surveillance is in place. Formal surveillance can increase the offender's perception of the risk of being caught and may accordingly reduce the incidence of crime in the specific areas under surveillance.



## Objective

To promote and assist formal surveillance activities both from within buildings and from nearby public space.

## Guidelines

- G1** Ensure that wherever possible building entrances and exits face the street or other well-used, accessible public space.
- G2** Provide large, easy-to-read street names and numbers to aid identification and reporting of crime sites by both the public and security agencies.
- G3** At public and emergency telephones, provide large easy-to-read phone numbers identifying police, other emergency services and taxis.
- G4** Identify and maintain important sightlines from useful vantage points.
- G5** Advertise with the use of signs or other means the existence (but not the detail) of formal surveillance measures.
- G6** Provide lighting appropriate to the site and situation.
- G7** Minimise opportunities for concealment.

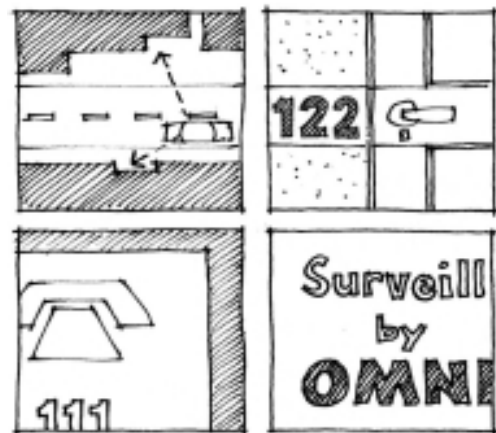



# Lighting

## Analysis

Good lighting after dark is essential to allow people to see and be seen. Illumination and visibility will reduce people's fear of crime, and when combined with other anti-crime measures, well-designed lighting may also prevent it. By increasing visibility, lighting:

- makes possible the formal and informal surveillance of urban public space and relevant publicly accessible parts of buildings
- reduces the opportunity for criminals to conceal themselves
- encourages people to use places rather than keep out of them.

Carefully designed lighting can not only reduce the opportunity for unobserved crime, it can help our urban public spaces become more useable at night. Such lighting may be specifically planned as outdoor or street lighting or it may include the spill of light onto the street from windows of nearby buildings.

### Where is lighting required?

A blanket application of more lighting may in some circumstances be neither possible nor desirable. Cost and energy use should be considered, as well as whether it is appropriate to use lighting at all. For example, lighting the first part of a path through a wilderness area which is neither policed nor frequently used may give people a false impression of safety and draw them into a dangerous area.

Lighting should target areas where good visibility after dark is justified by patterns of use. Lighting should be located where it will be most beneficial. Finally, lighting must be carefully designed for each specific situation or building with consideration of the detailed characteristics of form.

### Aesthetic benefits

As well as providing visibility, lighting also has an aesthetic impact. Lighting can and should improve the "nightscape" or aesthetic quality of those parts of urban public space that give the city its identity and which are well used at night. Lighting for visibility can also be used to accentuate significant buildings or important features within the city, and can be used to emphasise the special qualities of character areas - such as heritage or entertainment areas. This may in turn attract additional legitimate pedestrian activity to these areas after dark. However, such lit areas can sometimes provoke graffiti and vandalism when other controls are not in place, and design should take this into account.

## Detailed Design Considerations

The potential adverse effects of badly designed lighting should be considered and avoided. Over-lighting and glare, for example, may hinder informal surveillance from neighbouring properties rather than help it. Other factors to be considered include:

- the distribution of light to avoid excessive contrast
- accurate colour rendition to aid visibility
- the physical appearance of the light fittings, especially that they would not be obvious targets for stone-throwing vandals
- visual consistency and the relation of the lighting to that already in the area.

## Objectives

To provide lighting to illuminate those parts of urban public space that people commonly use at night, including building entrances, exits and other main routes of travel.

To light in a way and to a level that allows pedestrians to be identified and reduces the opportunity for concealment.

## Guidelines

- G1** Provide lighting to building entries and exits and the paths leading to these.
- G2** Emphasise lighting for safety and security on pedestrian pathways rather than roads.
- G3** Illuminate potential night-time concealment and entrapment spaces.
- G4** Where possible design the lighting within facilities so that it lights up the public space in and around them.
- G5** Avoid over-lighting and glare.
- G6** Direct lighting away from windows in neighbouring buildings.
- G7** Avoid creating shadows which may be used for concealment.
- G8** Do not light paths or spaces not intended for night-time use to avoid giving a misleading impression of their security or use.
- G9** Use feature lighting to emphasise entries to main pedestrian routes and important pedestrian spaces with feature lighting.

- G10** Light main routes attractively (in keeping with their use and streetscape character) to attract legitimate pedestrian activity after dark.
- G11** Locate light fittings where they will not be obscured by growing trees or other impediments.
- G12** Select light fittings of a type and robustness appropriate to their likely degree of exposure to vandalism, their likelihood of provoking vandalism and their ease of access for maintenance.

# Concealment

## Analysis

The obstruction of visibility along a pedestrian route by elements such as overgrown foliage, blind corners and large projections and recesses in adjacent walls can be a serious impediment to feeling and being safe. Any situation that allows concealment may serve as a point from which the criminal can wait and pick out potential victims, or attack them. Where places of concealment have certain characteristics of physical enclosure, they are also more likely to be used as sites for committing crimes.

### The benefits of visibility

Places that provide concealment reduce the effectiveness of surveillance measures and also reduce people's awareness of who or what lies ahead of them. Improving visibility and lessening the opportunity for concealment may allow people to avoid potential offenders, observe offenders, witness crime, and stop or report crime.

### Scope of application

Some public spaces and areas within the city such as bush reserves, parts of the Botanical Gardens and recreational walkways are relatively isolated, private and offer a myriad of possibilities for concealment. This Design Guide does not address the potential for concealment in these areas. Such areas are often valued precisely because they offer the opportunity to be away from other people. While it is important to maintain in such areas the very qualities that give people the option of experiencing isolation or privacy, it is also important that commonly used and important routes through these areas are relatively safe and do not offer unnecessary opportunities for concealment.

## Objective

To reduce or eliminate opportunities for concealment in, or at the edges of, frequently used publicly accessible spaces and facilities.

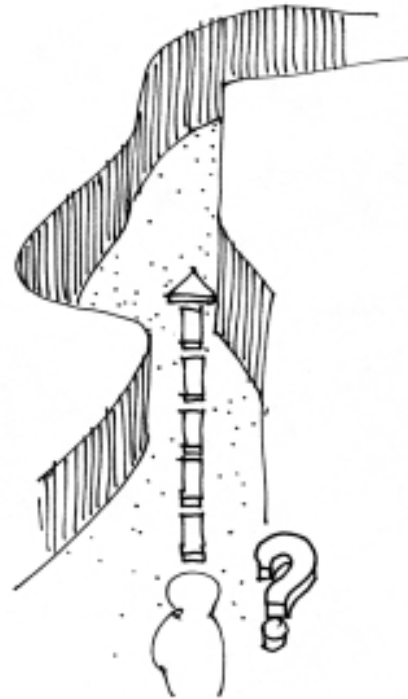

## Guidelines

- G1** Detail the fronts of buildings to minimise or eliminate entirely places that may offer the opportunity for concealment.

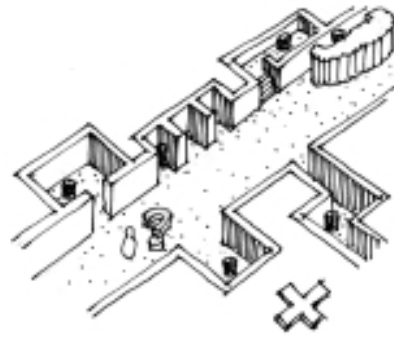

*reduced opportunity for concealment*

- G2** Select landscaping elements - shrubs and trees - whose main foliage is either visually permeable, or lower than 0.6m, or 2.0m or more above ground level.
- G3** Select planting of a type that will not as it matures impede visibility or provide concealment and entrapment opportunities for attackers.
- G4** Provide good sightlines along routes such as stairs, underpasses and paths, eliminating blind corners wherever possible.

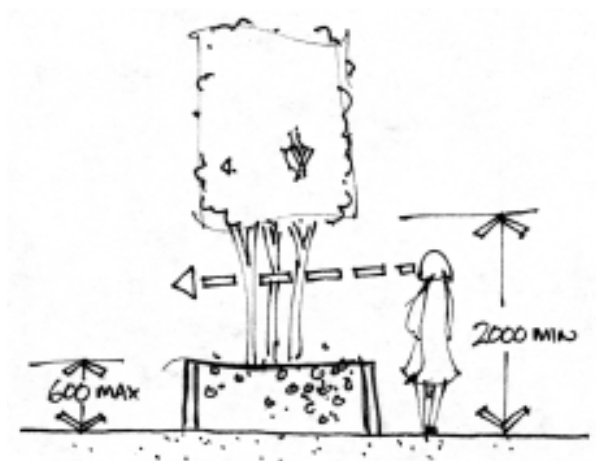

# Entrapment

## Analysis

Small confined areas, shielded on three sides by some sort of barrier, may be used by offenders to trap potential victims. These areas, known as entrapment spots, are often selected as the site for violent crimes against the person such as robbery, assault or rape. The physical enclosure of an entrapment spot is used by offenders to control their victims by inhibiting their opportunity for escape. Such areas often offer the opportunity for concealment during the commission of crime as they are also usually characterised by poor visibility from public space.

## Types of Entrapment

Entrapment may be "actual", where a space is defined by physically impenetrable barriers through which escape is not possible. Examples include walled alcoves, enclosed rooms, or stairs down to locked basement doors. The removal of physical barriers from such areas will reduce their entrapment potential.

Alternatively, entrapment may be "perceptual", where visually (but not physically) impermeable barriers give concealment and make people feel trapped. Thinking that they may be seen is often enough to deter a potential offender from using an area for entrapment. It follows that removing both physical and visual barriers will reduce the entrapment potential of an identified problem area and increase supervision over it at the same time.

## Movement Predictors

Potential entrapment spots are more likely to be used for criminal purposes and present a greater risk when they are near a public space or route, through or along which people are likely to be moving. Such spaces are known as movement predictors. They include, but are not limited to, streets, footpaths, public pathways, stairways, pedestrian bridges and tunnels. Movement predictors are not necessarily dangerous in their own right, but they make other places near them more dangerous. An offender can use their knowledge of the location of entrapment spots and the ability to predict the movement of potential victims to plan when and where to commit an assault.

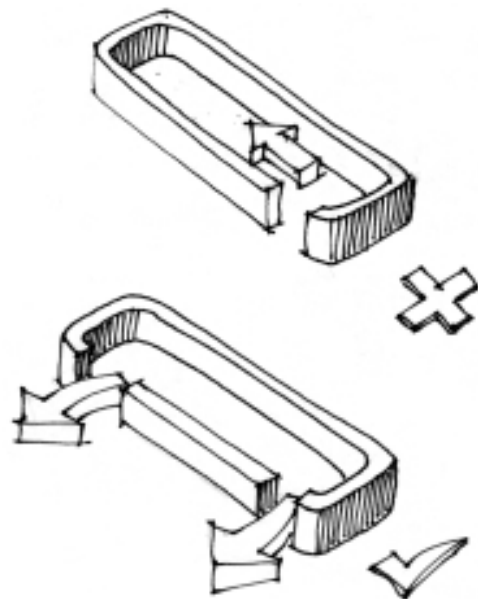

## Objectives

To eliminate any small, semi-enclosed spaces that may be used for entrapment purposes.

## Guidelines

- G1** Provide multiple exit points from any park, playground or otherwise enclosed area in which people might be trapped.
- G2** Control access to storage and service areas adjacent to pedestrian routes (such as store rooms and plant-rooms inside buildings).
- G3** Remove physical barriers or open out accessible small, enclosed spaces when these offer the potential for entrapment.
- G4** Use lighting and the removal of visual barriers to reduce the potential for concealment in any accessible enclosed area that may be used for entrapment.
- G5** Eliminate all potential entrapment areas that are on or within 30m of frequently used pedestrian routes, particularly those along which the likely movements of any pedestrian can be predicted by an offender.

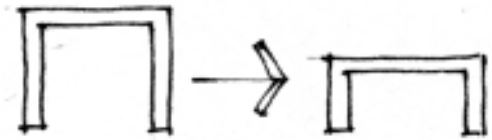
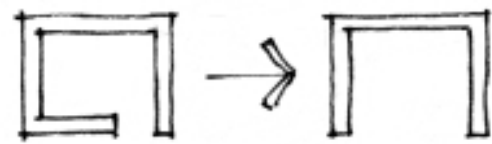
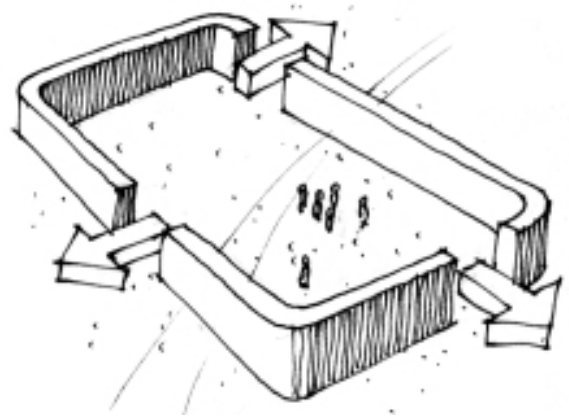

# Robustness

## Analysis

The physical robustness of the elements of public space - building fronts, hard and soft landscaping and street furniture - will determine their susceptibility to damage. This susceptibility will affect maintenance requirements. The existence of damage will also influence the public image of a building or area.

## Causes of Damage

While the popular image of vandalism is wilful damage, in reality this accounts for only about a quarter of damage. Other damage may be less destructive but is still significant. It may happen for "tactical" reasons, an example being political graffiti. It may result from normal wear and tear, or because an object or space is not sufficiently robust to cope with an unforeseen but legitimate use. Damage can occur when the environment is used in an unplanned way by children or young people for recreation. Damage may also result unless the environment is physically adapted to meet needs and demands not satisfied by its present form.

## Accommodating Legitimate Activity

It is difficult to predict all of the uses to which public space will be put, particularly given that uses and demand change over time. However, the elements that form urban space should be sufficiently robust to resist wilful damage and to accommodate a variety of legitimate uses. An environment detailed in such a way will not only be better able to maintain an orderly appearance, but will also offer people choice and be responsive to their various and sometimes unforeseen needs.

## Appearance

The symbolism of preventative measures should be considered. Overt signs of robustness and security will alert people to the potential for crime. In circumstances where the risk of crime is high, and crime or damage is likely to occur, this may be appropriate. However, environments designed to be too robust may impart an aggressive image which sets up a challenge and provokes an adverse reaction. Overly robust, hard architecture can provoke vandalism.

Where there is no undue risk of crime or damage, excessive signs of criminal deterrence may give a misleading impression and unnecessarily increase fear of crime in the area.

It is the prerogative of building owners and users to initiate preventative measures at the edges of buildings. To avoid giving the impression of a building under siege, robustness should ideally be an integral part of the design rather than an add-on or remedial component. The primary consideration should be the basic structural integrity of well-constructed and secure walls, doors and windows with materials and components chosen for their resistance to damage.



## Objective

To ensure that publicly accessible parts of buildings and public spaces resist damage from vandalism or inappropriate use while maximising the opportunity for legitimate public activities and uses to occur.

## Guidelines

- G1** Use design measures to eliminate the opportunity for unsafe, anti-social and criminal activities to occur, or reduce damage resulting from them, without limiting the range of legitimate activity that can take place in any space.
- G2** In areas expected to suffer damage either from vandalism or normal wear and tear, materials and components should be either vandal-resistant and very durable or should be detailed to be inexpensive and easy to replace or repair if damaged. This second approach requires maintenance or repair procedures to be allowed for.
- G3** Specify easily replaced fittings, standard sized panels and panes and finishes in stock colours to allow simple and speedy replacement or repair.
- G4** Integrate any necessary security features into buildings or public spaces by designing them to be intrinsic, unobtrusive or a positive decorative feature.
- G5** Accessible ground floor windows in areas where damage or forced entry is likely to occur may be sized or subdivided to prevent unauthorised access and glazed with materials appropriate to their size, location and building type. Various grades of toughened, laminated or anti-bandit glass are available and present design options in addition to the use of various types of grille.
- G6** Design the edge of buildings fronting public space to accommodate rather than preclude a variety of legitimate activities. Steps, bollards, handrails, the backs of benches, flower boxes and other objects in public space may, for example, be used as seats and should be designed to allow such secondary uses without damaging or threatening the main function of the building.

# Maintenance

## Analysis

The "image and milieu" or public perception of a part of the urban environment is influenced by the cleanliness and state of repair of its public spaces and buildings.

People's perception of order or disorder within an urban area affects the way they use it. An area that is neglected and in a state of disorder provides the conditions that can motivate criminals and provide better conditions for crime.

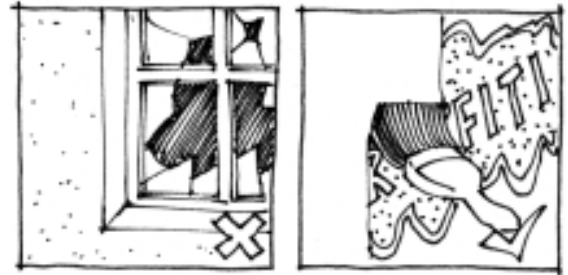

### Effects of Poor Maintenance

Derelict buildings, poorly maintained vacant lots and other unassigned and generally unused but accessible spaces effectively indicate abandonment and lack of ownership. This signals their availability for claiming by criminals and they may provide convenient locations for anti-social or criminal behaviour. A combination of badly maintained lighting and landscaping could provide the facility of concealment and entrapment, in which serious and violent crime against the person is more likely to occur. Neglect and disorder will increase the public's fear of crime and may dissuade people with legitimate intent from using an area. Or they may have no option but to use an area and do so in fear.

### Benefits of Good Maintenance

Conversely, an area that is in good repair is more likely to be inhabited and claimed by legitimate users rather than criminals. Should an area be well maintained and orderly, the potential offender's perception of the likelihood of being caught in criminal activity will rise. When this image is supported by a community that takes a proprietorial interest and that is seen to be prepared to respond to disorder, the risk of criminal activity and the fear of crime is reduced.

For example, prompt repair of damage or vandalised property signals to the community in general (and vandals in particular) that the area is being looked after. It deflates the efforts of graffiti scrawlers and vandals and breaks the cycle of environmental degradation that can result from a combination of vandalism and poor maintenance. The prompt repair of damage certainly reduces the likelihood of subsequent cumulative damage.

## **Objectives**

- O1** To ensure that building fronts, lighting and public space are well maintained.
- O2** To ensure that damage is promptly repaired.

## **Guidelines**

- G1** Specify materials and components and design with both cost in use and ease of maintenance in mind.
- G2** Set maintenance procedures in place and monitor these to ensure that repair is properly and promptly carried out.
- G3** Design the fronts of buildings and nearby public space to encourage users to take a proprietorial interest in and formal or informal responsibility for its maintenance.